

## **LS1, LS2.5 & LS5 Series Universal Test Machines**

### **User Manual**



## WARRANTY

This instrument is warranted against defects in workmanship, material and design for one (1) year from date of delivery to the extent that AMETEK will, at its sole option, repair or replace the instrument or any part thereof which is defective, provided, however, that this warranty shall not apply to instruments subjected to tampering or, abuse, or exposed to highly corrosive conditions.

THIS WARRANTY IS IN LIEU OF ALL OTHER WARRANTIES WHETHER EXPRESS OR IMPLIED AND AMETEK HEREBY DISCLAIMS ALL OTHER WARRANTIES, INCLUDING, WITHOUT LIMITATION, ANY WARRANTY OF FITNESS FOR A PARTICULAR PURPOSE OR MERCHANTABILITY. AMETEK SHALL NOT BE LIABLE FOR ANY INCIDENTAL OR CONSEQUENTIAL DAMAGES, INCLUDING, BUT NOT LIMITED TO, ANY ANTICIPATED OR LOST PROFITS.

This warranty is voidable if the purchaser fails to follow any and all instructions, warnings or cautions in the instrument's Instruction Manual.

If a manufacturing defect is found, AMETEK will replace or repair the instrument or replace any defective part thereof without charge; however, AMETEK's obligation hereunder does not include the cost of transportation, which must be borne by the customer. AMETEK assumes no responsibility for damage in transit, and any claims for such damage should be presented to the carrier by the purchaser.

## TRADEMARKS

AMETEK is a registered trademarks of AMETEK, Inc. LLOYD INSTRUMENTS is a trademark of AMETEK, Inc. Other trademarks are the property of their respective owners.

## SUPPORT

AMETEK Lloyd Instruments Ltd  
Steinyng Way  
Bognor Regis  
West Sussex  
UK  
PO22 9ST

Tel: +44 (0) 1243 833 370  
Fax: +44 (0) 1243 833 401  
techsupport@ametek.co.uk  
www.lloyd-instruments.co.uk

AMETEK Measurement and Calibration  
Technologies  
8600 Somerset Drive  
Largo, FL 33773  
USA

Tel: +1-727-536-7831  
Tel: +1-800-527-9999 (within USA only)  
www.chatillon.com

## CAUTION!

**HIGH FORCES ARE OFTEN INVOLVED WITH THE MATERIAL TESTING PROCESSES.**

**THE MACHINE IS POWERED BY MAINS SUPPLY VOLTAGE**

**CLASS 1 PRODUCT, MUST BE CONNECTED TO A MAINS SOCKET OUTLET WITH A PROTECTIVE EARTH CONNECTION**

**DO NOT POSITION THE EQUIPMENT SO THAT IT IS DIFFICULT TO OPERATE THE DISCONNECT DEVICE (MACHINE MAINS INLET SOCKET)**

**IF THE EQUIPMENT IS USED IN A MANOR NOT SPECIFIED BY THE MANUFACTURER, THE PROTECTION PROVIDED BY THE EQUIPMENT MAY BE IMPAIRED**

**TO MAINTAIN ALL ASPECTS OF THE SPECIFICATION, ONLY LLOYD INSTRUMENTS APPROVED ACCESSORIES CONNECTIONS AND COMPONENTS SHOULD BE USED**

**STRICTLY ADHERE TO ALL SPECIFIED SAFETY PROCEDURES**

**READ THIS MANUAL BEFORE USING THE MATERIALS TESTING MACHINE.**

## ICONS



### WARNING

The raised hand icon warns of a situation or condition that may lead to personal injury or death. Do not proceed until the warning is read and thoroughly understood. Warning messages are shown in bold type.



### DANGEROUS VOLTAGE

The lightning icon warns of the presence of an uninsulated dangerous voltage within the product enclosure that might be of sufficient magnitude to cause serious shocks or death. Never open the enclosures unless you are an authorized and qualified LLOYD INSTRUMENTS' service personnel. Never open any enclosure when power is connected to the system or its components.



### CAUTION

The exclamation point icon indicates a situation or condition that may lead to equipment malfunction or damage. Do not proceed until the caution message is read and thoroughly understood. Caution messages are shown in bold type.



### NOTE

The note icon indicates additional or supplementary information about the action, activity or concept. Notes are shown in bold type.

## General Safety

General safety precautions must be followed when using this LLOYD INSTRUMENTS product. Failure to observe precautions and warnings may result in damage to the equipment, or injury to personnel.

It is understood that safety rules within companies vary. If a conflict exists between the material contained in all LLOYD INSTRUMENTS' User's Guides and the rules of a company using a LLOYD INSTRUMENTS product, the more stringent rules should take precedence.

## Safety Considerations

The LS is completely enclosed and provides no potentially hazardous outputs. Safety considerations are related to the power connections and physical mountings.

Electronic and mechanical components housed within the LS covers are to be serviced by authorized LLOYD INSTRUMENTS' representatives only.

The final and full compliance with the requirements of the MSD 2006-42-EC will be dependent on the industry, application, material (to be tested), location (of the use), ect. the final user must take the necessary steps to ensure the

safety of the operator, other people, machine and properties by providing guards, shields, screen, adequate lighting, adequate ventilation, ect. Furthermore, when the machine is installed, wired and ready for its intended use the final user must conduct the final Risk Assessment on the machine, including all such safety measures (shield, guard, etc.), to satisfy the requirements of Machinery Directive and EHSR (Essential Health and Safety Requirements).



### **The LS Frame has a potential to**

**crush objects!** Please ensure your hands are kept away from the LS moving arm.



### **When designing custom fixtures!**

Ensure fixtures load ratings exceed the LS load cell maximum load rating. I.e. If load cell is 1kN the fixtures must be designed to exceed 1kN load.

## DECLARATION OF CONFORMITY

We: **Ametek, Inc.**  
 of **8600 Somerset Drive**  
**Largo, FL 33773,**  
**USA,**

In accordance with the following Directive(s):

2004/108/EC The Electromagnetic Compatibility Directive  
 2006/42/EC The Machinery Directive

Hereby declare that:



The following Lloyd Instruments **Single Column Material Testing Machines (LLOYD is a brand name**  
 owned by Ametek, Inc)

Machine	Part No.
LS1	LS1SH-115V, LS1SH-230V, LS1SC-115V, LS1SC-230V, LS1EH-115V, LS1EH-230V, LS1EC-115V, LS1EC-230V
LS1	LS1SH-230V-CNAU, LS1SC-230V-CNAU, LS1EH-230V-CNAU, LS1EC-230V-CNAU
LS1 Page	LS1PH-115V, LS1PH-230V, LS1PC-115V, LS1PC-230V, LS1XH-115V, LS1XH-230V, LS1XC-115V, LS1XC-230V, LS1XC-230V
LS1 Page	LS1PH-230V-CNAU, LS1PC-230V-CNAU, LS1XH-230V-CNAU
TA1	TA1SH-115V, TA1SH-230V, TA1SH-230V-CNAU, TA1SC-115V, TA1SC-230V, TA1SC-230V-CNAU, TA1EH-230V
FT1	FT1SC-115V-10N, FT1SC-230V-10N, FT1SC-230V-10N-CNAU, FT1SC-115V-50N, FT1SC-230V-50N
FT1	FT1SC-230V-50N-CNAU, FT1SC-115V-100N, FT1SC-230V-100N, FT1SC-230V-100N-CNAU
LS2.5	LS2KSEH-115V, LS2KSEH-230V, LS2KSEC-115V, LS2KSEC-230V, LS2KSH-230V-CNAU, LS2KSEC-230V-CNAU
LS2.5	LS2KXSH-115V, LS2KXSH-230V, LS2KXSC-115V, LS2KXSC-230V, LS2KXSH-230V-CNAU, LS2KXSC-230V-CNAU
LS5	LS5SH-115V, LS5SH-230V, LS5SC-115V, LS5SC-230V, LS5SH-230V-CNAU, LS5SC-230V-CNAU
LS5	LS5PH-115V, LS5PH-230V, LS5PC-115V, LS5PC-230V, LS5PH-230V-CNAU, LS5PC-230V-CNAU

Serial Number: 100000 and up

Are in conformity with the applicable requirements of the following documents

Ref. No.	Title
EN 61010-1:2010	Safety Requirement for Electrical Equipment for measurement, control and laboratory use. General requirements
EN ISO 14121-1:2007	Safety of Machinery, Risk assessment Principles
EN 61326-1: 2006	Electrical equipment for measurement, control and laboratory use, EMC requirements. General requirements
BS EN 61326-2-3: 2006	Electrical equipment for measurement, control and laboratory use. EMC requirements. Particular requirements. Test configuration, operational conditions and performance criteria for transducers with integrated or remote signal conditioning

I hereby declare that the equipment named above has been designed to comply with the relevant sections of the above referenced specifications and is in accordance with the requirements of the Directive(s)

Signed by:

Name: **Douglas Tilghman**  
 Position: **Division Vice President, Engineering**  
 Done at: **8600 Somerset Drive, Largo, Florida 33773, USA**  
 On: **March 21, 2013**

Document ref. No. ER-428

The technical documentation for the machinery is available from:

Name: **Joel Frie**  
 Position: **Division Vice President & Business Unit Manager**  
 Address: **Ametek, Inc. Gydevang 32, 3450 Lilkerod, Denmark**



## TABLE OF CONTENTS

1.0	<b>INTRODUCTION</b> .....	6	9.0	<b>SETTING UP A NEW TEST</b> .....	35
1.1	Safety .....	7	9.1	Pre-defined Test Setups .....	35
2.0	<b>ELECTRICAL SAFETY</b> .....	7	9.2	Default Global Settings .....	37
3.0	<b>INSTALLATION</b> .....	8	9.3	Editing a Pre-defined Test Setup .....	37
3.1	Unpacking .....	8	9.4	Password Access .....	37
3.2	Setting Up Your Machine .....	8	9.5	Renaming the Test .....	38
3.3	Securing to the workbench .....	9	9.6	Deleting a Test .....	38
3.4	Voltage Selection .....	9	9.7	Global Settings .....	38
3.5	Computer and Other Connections .....	10	9.8	Setting a Password .....	39
3.6	ON-OFF Switch .....	10	9.9	Safety Load Limit .....	39
3.7	Fitting the Load Cell .....	11	9.10	Slow Jog Speed .....	39
3.8	Additional Load Cells .....	11	9.11	Setting for Printer .....	39
3.9	Setting Up the Pogo LFPlus .....	12	9.12	Grip Protection Settings .....	39
4.0	<b>LOAD CELLS</b> .....	13	9.13	Current Language .....	39
4.1	Care of Load Cells .....	13	9.14	Machine Stiffness .....	40
4.2	Fitting Load Cells .....	13	9.15	Test Setup Display .....	40
4.3	General Precautions .....	14	9.16	Test Type .....	41
5.0	<b>ACCESSORIES</b> .....	15	9.17	Selecting Machine Stiffness Compensation .....	43
5.1	Expanded Table .....	15	9.18	Test Options .....	43
5.2	Drip Tray .....	17	9.19	Test Results .....	46
5.3	Extensometer Interface .....	17	9.20	Pass/Fail Values .....	46
6.0	<b>CONTROL CONSOLES</b> .....	18	9.21	Defining Sample .....	47
6.1	Main Control Console Description .....	18	9.22	Pre-Test Questions .....	47
6.2	Keypad Operation and Description .....	19	10.0	<b>ERROR CONDITION</b> .....	48
6.3	The Display .....	21	10.1	Error Conditions .....	48
6.4	"SWITCH-ON" Display .....	21	11.0	<b>CLEANING AND MAINTENANCE</b> .....	50
6.5	Handheld Remote Control .....	22	11.1	Cleaning External Finish and Trim .....	50
6.6	Displayed units on the handheld remote control .....	23	11.2	Maintenance .....	50
7.0	<b>OPERATIONAL PRECAUTION</b> .....	24	12.0	<b>TECHNICAL SPECIFICATION</b> .....	51
7.1	Safety .....	24	12.1	Technical Specification - LS1 .....	51
7.2	Emergency Stop .....	25	12.2	Technical Specification - LS1 Extended .....	51
7.3	Splinter Shields .....	25	12.3	Technical Specification - LS5 .....	52
7.4	Lower Anchor Pin Adjustment .....	26	12.4	Technical Specification - LS2.5 Extended .....	52
7.5	Limit Stops .....	27	12.5	Overall Dimensions LS .....	53
8.0	<b>PERFORMING A TEST</b> .....	29	13.0	RoHS tables .....	54
8.1	Performing a Test .....	29	14.0	Spare Parts Kits .....	56
8.2	Test Parameters .....	29			
8.3	Selecting a Test .....	30			
8.4	Starting a Test .....	33			
8.5	Stopping a Test .....	33			
8.6	Printing Test Results .....	33			
8.7	Canceling or Accepting Results .....	33			
8.8	Viewing the Statistics .....	34			
8.9	Error Conditions .....	34			

## 1.0 INTRODUCTION

Welcome to your new LS series advanced, single column, universal testing machine. It incorporates an extensive range of features making it ideal for performing complex testing applications. The machine is microprocessor controlled and uses world proven 32 bit technology for highly accurate load measurement and rapid data acquisition.

When purchased with the manual display console the stand alone system is capable of storing up to 600 test results from a choice of 10 user programmable test set-ups, or may be connected via its USB output to a personal computer running NEXYGENPlus™, providing almost unlimited testing capability and result manipulation facilities.

The high stiffness frame incorporates a cross-head guidance system to prevent side loading of the sample under test. The crosshead is driven by single lead screw, motor and DC PWM system to achieve a wide speed range over the full load range. The machine is capable of running full load at full speed. A range of highly accurate, interchangeable loadcells are available for tension, compression and cycling through force measurements. The system is ideal for use in production, quality control, educational and research environments.

All LS series systems are designed to meet a broad range of applications. This is achieved mainly through the embedded control software and easily configurable data acquisition software, available as an optional extra.

NEXYGENPlus™ software is fully WINDOWS® compliant and compatible, it seamlessly integrates with contemporary MICROSOFT® Office programs using OLE2 technology. The program is easy to use, making use of drop down windows prompts, drag and drop, cut and paste routines. Data can easily be exported to programs such as EXCEL®, ACCESS®, OUTLOOK® and POWERPOINT® for further manipulation, and enhanced presentation. NEXYGENPlus™ software contains a library of pre-programmed test set-ups for conducting fully automated tests, in accordance with international standards.

For advice and information about the NEXYGENPlus™ data analysis and applications software, please contact your authorised LLOYD INSTRUMENTS Sales Representative.



*LS Materials Testing Machine  
with optional grips and load cell*

## 1.1 SAFETY



**CAUTION:** Materials testing machines are very safe to use providing the instructions presented in this manual are followed precisely. We would like to draw your attention to both the Electrical Safety (Section 2.0 page 7) and Operational Precautions, (Section 7.0 page 23). Please refer to both sections for details on safe operation of this equipment before operating your materials testing machine.

Transparent splinter shields are available as an option to enclose the test sample if there is any danger of samples shattering as a result of the test. These shields have an electronic interlock such that the test cannot be started until the hinged shield is closed. While not mandatory for many applications and countries, AMETEK Lloyd Instruments Ltd. strongly recommends that users consider fitting this option.

## 2.0 ELECTRICAL SAFETY

1. The LS Universal Test Machine has been designed to meet the requirements of BS EN 61010-1 : 2010 Safety requirements for electrical equipment for measurement, control and laboratory use.
2. The User Manual contains some information and warnings, which have to be followed by the user to ensure safe operation and to keep the machine in safe condition.
3. The machine has been designed for indoor use. It may occasionally be subjected to temperatures between -10°C and +35°C (14°F and 95°F) without degradation of its safety.
4. Before switching on the machine make sure that it is set to the voltage of the mains electricity supply.
5. This machine complies with electrical safety grade Class 1, which means that it is "earthed apparatus" and requires the mains plug to contain a protective earth terminal. The mains plug must only be inserted in a socket outlet provided with a protective earth contact. The protective action must not be negated by the use of an extension cord without a protective conductor.
6. Make sure that only fuses with the required rated current and of the specified type are used for replacement. The use of makeshift fuses and the short-circuiting of fuse holders is prohibited.
7. There are no user serviceable parts within the machine.
8. The machine must be disconnected from all voltage sources before it is opened for any adjustments, replacement, maintenance or repair.
9. Capacitors inside the machine may still be charged even if the machine has been disconnected from all voltage sources.
10. Any adjustment, maintenance or repair of the opened machine connect to the mains supply voltage should be avoided as far as possible but if inevitable, must only be carried out by a skilled person who is aware of the hazard involved.
11. Only use safety approved power cords that come with the LS Series test machines.

## 3.0 INSTALLATION

### 3.1 UNPACKING

The LS on its own, without the packing and accessories weighs more than 50kg (110lb). Therefore, safe lifting practices should be employed and lifting equipment used as necessary.

The LS test machine is packed in a rugged shipping crate to minimize damage caused from shipping mishandling.



**NOTE:** Please make a careful visual inspection of all the parts made to ensure that there is no obvious transit damage.



**NOTE:** Please check that you have received all the parts that were ordered. If there is any damage, or parts missing, please report them to your authorised LLOYD INSTRUMENTS representative.

### 3.2 SETTING UP YOUR MACHINE

The LS Materials Testing Machine is a heavy item and great care should be taken in choosing the location where it is to be installed. Ensure the bench is capable of remaining firm and stable, withstanding the combined weight of the machine and any accessories supplied. Please see the Specification page at the end of this manual for the weight of the apparatus. The machine must be vertical, otherwise the results may be affected, particularly for very low loads.



**CAUTION:** At no time should the LS be lifted by placing hands under the frame feet.

The LS must be positioned such that the front can be easily accessed, and that the emergency stop button is not obstructed in any way. Please ensure utmost care is taken when lifting this instrument, use safe working practices. Lifting equipment should be used as necessary.

The two recommended methods are described below:

1. Lifting with a pallet. A pallet may be fitted under the machine so it may be lifted to the desired position with a forklift or a suitable lifting trolley.
2. Lifting by hand. The machine can be lifted manually, at least 2 people should be employed to do this as the machine weighs more than 50kg (110lb). Do not lift using plastic base cover. Lift using aluminum bottom plate as a support.

The LS test machine may be shipped with the load cell cable plugged into itself during shipping. If cable is plugged in as shown to the right remove the 15 pin connector and plug it into the 15 pin D-sub connector in the lower rear of the LS test machine.

The LS2.5 Extended test machine comes with bench mounting kit SPK/LS/0050 so that it can be secured properly to a workbench. Reference section 3.8 for mounting hole locations.





### 3.3 SECURING TO THE WORKBENCH

The LS series material tester is a heavy item and cannot normally tip over. However, if there is the possibility that users can pull against the vertical column, then there is a risk that the machine may be pulled over.

It is required that the LS series material tester is secured to the bench using the 2 tapped holes in the base of the machine. The template below shows the location of 2 holes that are required in the top of the workbench for the two M6 bolts. The LS series test machine has 2 screws, 2 spacers and two washers as part of the standard accessories to properly mount the test machine to a standard workbench. If the two mounting screws are the wrong length you may substitute the screws with standard M6 X P1.0 screws.

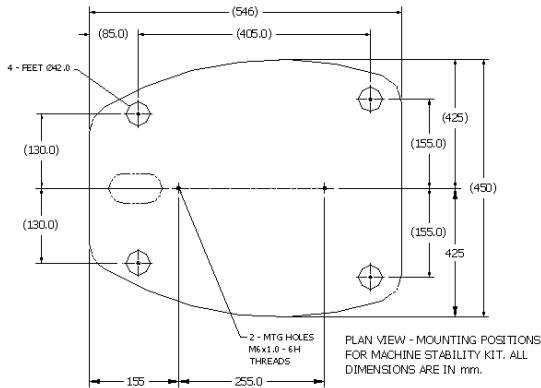

### 3.4 VOLTAGE SELECTION

The LS can be used with electricity supplies of either 230Vac  $\pm 10\%$  or 115Vac  $\pm 10\%$ . The power input cable should be inserted at the rear of the machine. Before switching on the machine you **MUST** check the correct voltage has been selected on the mains input connector. Ensure that the selection is correct for the voltage of your power supply.



**CAUTION:** You must check to ensure the correct voltage has been selected on the mains input connector before you switch the machine ON.

To change the voltage setting, unplug the mains lead from the back of the machine and use a screwdriver to open the voltage selector. The screwdriver should then be used to move the selector from the 115V position to the 230V position as appropriate. You **MUST** also check that the fuse rating is suitable for the supply voltage that you are using. The fuses (live and neutral) located inside the power input connector.

*Voltage Selection*

*Main Power Switch*

*Power Mains Input*



The LS test machine uses two ceramic high breaking capacity type fuses (20mm x 5mm) as shown above. The two fuses are assembled into the power entry module fuse block as shown above.



**WARNING:** Replace the fuses with the exact same type and rating as the ones supplied by factory. Do not replace with higher or lower rated fuses.

### Fuse Ratings and Part Numbers

<u>Model</u>	<u>Fuse Rating</u>	<u>Part Number</u>	<u>Type</u>
LS1 - 115VAC	3.15A	SPK/LS/0011/A	T3A15H250V
LS1 - 230VAC	3.15A	SPK/LS/0011/A	T3A15H250V
LS5 - 115VAC	6.3A	SPK/LS/0011/B	T6A3H250V
LS5 - 230VAC	6.3A	SPK/LS/0011/B	T6A3H250V

### 3.5 COMPUTER AND OTHER CONNECTIONS

Use lead part number CBT/1357/00, supplied in the accessory kit with the LS, to connect the machine to a computer.



**NOTE:** To maintain EMC compatibility, only connection leads supplied by LLOYD INSTRUMENTS should be used to connect this equipment to computers and/or accessories.

*Extensometer Interface Connector*

*Load Cell Cable Connector*

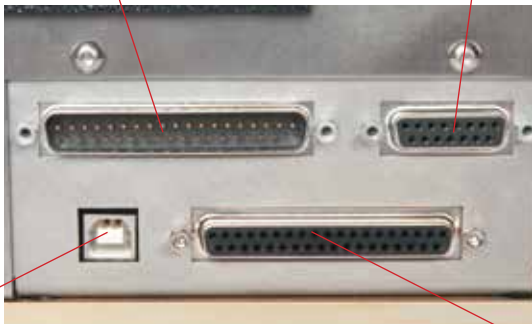

*USB Port*

*Hand Held Remote or Main Console Connector*

*Emergency Stop Button*

*Safeline Button*

*When illuminated, the safeline switch is open. There is no crosshead movement or motor control. Depress the button to close the switch and allow for motor and crosshead movement.*



### 3.6 ON-OFF SWITCH

The main power switch is located on the machine base at the rear. The switch is a rocker type with positions O and I. Press O to turn power off. Press I to supply power to the machine. If the safeline button illuminates the switch is open- there is no power to the crosshead motor circuit and the crosshead cannot move. Depress the safeline button, the light on the safeline button will turn off meaning the switch is closed. Crosshead movement can now be controlled. Use the main power switch to turn power off when the machine is not required.

### 3.7 FITTING THE LOAD CELL

Before the machine is powered up, or any test set-ups are entered, the Load Cell should be fitted.

Carefully unpack the Load Cell(s) supplied with your machine. Please make all operators aware that they are precision load measuring devices and should be treated with great care. Please read SECTION 4.0 LOAD CELLS before proceeding further.



**NOTE:** Load cells are precision measuring devices. Always handle load cells with extreme care to prevent damage.

### 3.8 ADDITIONAL LOAD CELLS

The following standard Load Cells are available for your LS.

Description	Accuracy	Capacity	Order Number
YLC-0005-A1	0.5% accuracy	5N	01/3871
YLC-0010-A1	0.5% accuracy	10N	01/3872
YLC-0020-A1	0.5% accuracy	20N	01/3873
YLC-0050-A1	0.5% accuracy	50N	01/3874
YLC-0100-A1	0.5% accuracy	100N	01/3875
YLC-0250-A1	0.5% accuracy	250N	01/3876
YLC-0500-A1	0.5% accuracy	500N	01/3877
YLC-1000-A1	0.5% accuracy	1000N	01/3878
YLC-2500-A1	0.5% accuracy	2500N	01/3879
YLC-5000-A1	0.5% accuracy	5000N	01/3880

#### LS Load Cell resolution

Load Cell	LBF Resolution	N Resolution	KGF Resolution	GF Resolution
5N	1LBF X 0.00001 LBF	5 N X 0.0001 N	0.5 KGF X 0.00001 KGF	500 GF X 0.01 GF
10N	2 LBF X 0.0001 LBF	10 N X 0.0001 N	1 KGF X 0.00001 KGF	1000 GF X 0.01 GF
20N	5 LBF X 0.0001 LBF	20 N X 0.001 N	2 KGF X 0.0001 KGF	2000 GF X 0.1 GF
50N	10 LBF X 0.0001 LBF	50 N X 0.001 N	5 KGF X 0.0001 KGF	5000 GF X 0.1 GF
100N	20 LBF X 0.001 LBF	100 N X 0.001 N	10 KGF X 0.0001 KGF	10000 GF X 0.1 GF
250N	50 LBF X 0.001 LBF	250 N X 0.01 N	25 KGF X 0.001 KGF	25000 GF X 1 GF
500N	100 LBF X 0.001 LBF	500 N X 0.01 N	50 KGF X 0.001 KGF	50000 GF X 1 GF
1000N	200 LBF X 0.01 LBF	1000 N X 0.01 N	100 KGF X 0.001 KGF	100000 GF X 1 GF
2500N	500 LBF X 0.01 LBF	2500 N X 0.1 N	250 KGF X 0.01 KGF	250000 GF X 1 GF
5000N	1000 LBF X 0.01 LBF	5000 N X 0.1 N	500 KGF X 0.01 KGF	500000 GF X 1 GF

### 3.9 SETTING UP POGO LS

Lloyd Instruments Limited produces a range of machines that can be mounted on specially designed frames that can be used for testing a wide range of bulky items such as cardboard cartons, crates and furniture.

These "Pogo" machines have a linear bearing fitted in the fixed lower crosshead through which a rod runs, connecting the load cell and the compression platens mounted below the machine within the frame.

Because the mountings protrude from the bottom of the LS, the machine cannot stand on it's own until it is fitted and secured to the mounting frame or workbench.

The Pogo Rod should be fitted last. Secure the LS to the top of the frame as per the instructions supplied with the frame. Insert the rod through the bearing on the lower (fixed) crosshead of the LS and connect to the Bottom Platen. Connect to the Loadcell last.



**CAUTION:** Suitable lifting equipment should be employed.

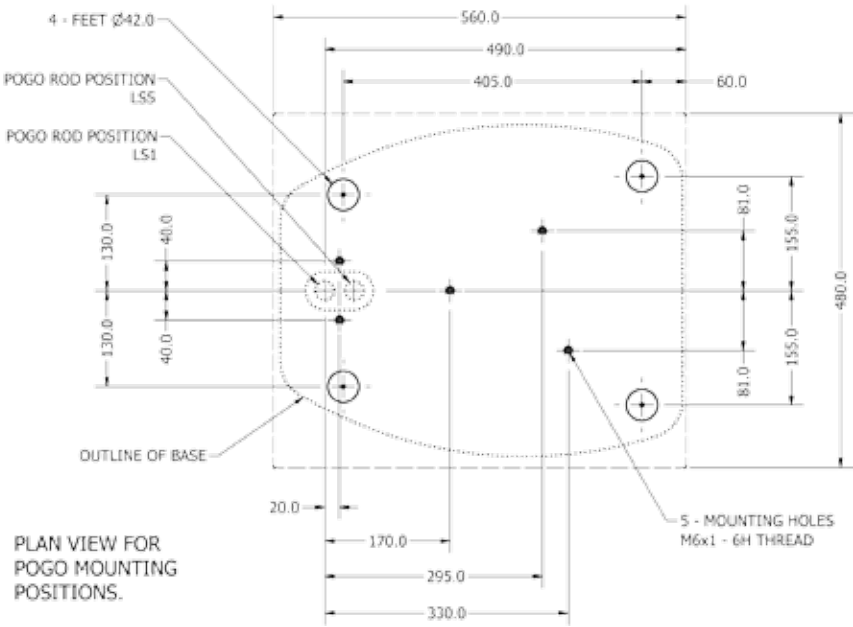

## 4.0 LOAD CELLS

### 4.1 CARE OF LOAD CELLS

ALL machine operators should be aware that LLOYD INSTRUMENTS' Load Cells are precision force measuring instruments, which should be treated with the utmost care to avoid accidental damage. In particular low force Load Cells are easily damaged if abused or used without sufficient care.



**NOTE:** Do not submit Load Cells to physical shock of any kind. DO NOT DROP!



**NOTE:** When a Load Cell is removed from a machine immediately put it in a safe and dry place.

### 4.2 FITTING LOAD CELLS

Place the Load Cell fixing screw through the hole in the crosshead and carefully offer up the load cell with the connecting lead facing inwards under the crosshead.

Screw the fixing screw (A) into the load cell (D), taking care to ensure that the locating dowel (B), when fitted) on the load cell sits in the hole in the moving crosshead. Tighten the screw with the 8mm HEX key provided. Insert the load cell plug (C) in the socket on the top of the moving crosshead and finger tighten the two retaining screws.

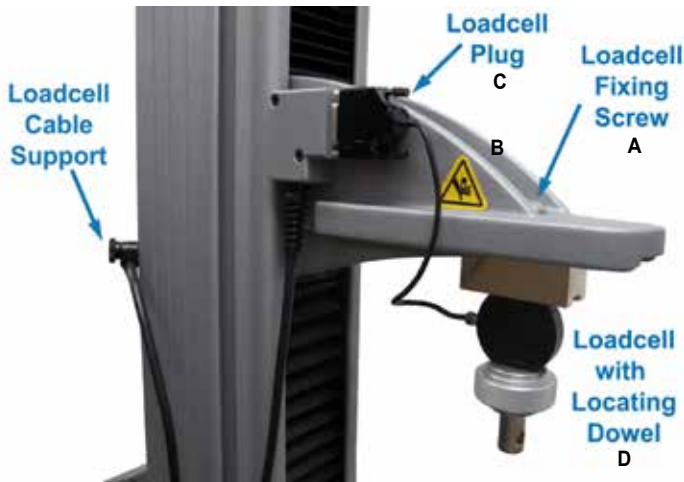

*LS Load Cell Fitting*

The Load Cell Cable Support can be adjusted up or down on the LS Column Extrusion using the thumb screw. Ensure there is plenty of length in the cable so that the crosshead can travel without pulling the cable assembly.

### 4.3 GENERAL PRECAUTIONS

The following points should be considered:

1. When installing the upper grip (particularly heavy ones) on the load cell eye end, avoid bumping the eye end. If the grip is a close fit, DO NOT FORCE IT, establish the reason and rectify. Immediately set, or re-set, the bottom limit stop so the grips will not meet when the crosshead is lowered. See section 7.5 LIMIT STOPS.
2. In both tension and compression tests, centre the specimen in line with the axis of the load cell and the bottom fixed anchoring device or pin to avoid side thrust.
3. In compression tests, care must be taken to avoid bringing the platens together or against solid specimens at high speed. Load cells thus damaged cannot be repaired. Ensure that the lower crosshead limit is set correctly. See section 7.5 LIMIT STOPS.
4. In compression tests, if special lower fixtures are used, ensure that they are fixed in position so they cannot be accidentally moved to block the normal downward movement of the upper fixture, e.g. where a tongue on the upper fixture must fit into a slot in the lower fixture. See section 7.4 LOWER ANCHOR PIN ADJUSTMENT.
5. Avoid overloading beyond the load cell rated capacity. Prior to testing ensure, if possible, that the maximum force anticipated will not exceed the capacity of the cell installed. If maximum capacity is approached during a test, run the machine at slow speed in local mode, and reverse the crosshead if capacity is exceeded.
6. LLOYD INSTRUMENTS load cells are built to exceed the standards as set out by ASTM, BS, DIN etc. All load cells on LS machines are user-changeable. Various capacities are available from 5N up to the capacity of the frame. While cells may be used below 10% of capacity it is recommended that, when such lower forces are anticipated, a lower force cell be installed such that the test force will fall in the upper 90% of its range. This will give the best signal to noise performance of the load measuring system.



**NOTE:** All machines incorporate overload protection, which will stop the machine if capacity is exceeded in either tension or compression. However, at higher speeds, momentum may carry the crosshead far enough after shut-off to damage the cell. All load cells can be damaged this way but in low force cells this distance is very short. Load cells that incur damage due to overloading cannot be repaired.

## 5.0 ACCESSORIES

### 5.1 EXPANDED TABLE

An extended base table is available to assist with the testing of wider items. There are 2 versions of the extended table which has 25 tapped holes strategically placed for easy anchoring of the part to be tested using customised jigs and fixtures, additional holes may be added by the user, 1 version has M6 tapped holes the other version has # 10-32 tapped holes



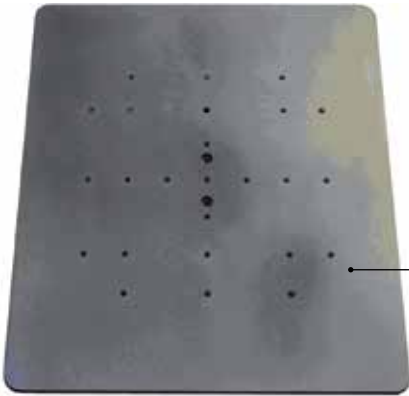

Twenty-five (25) tapped holes for attaching custom fixtures.

*LS Extended Work Table*

There are two (2) versions of the table. The part numbers for each are as follows:

M6 Threads	SPK/LS/0001
#10 – 32 Threads	SPK/LS/0002



## 5.2 DRIP TRAY

The optional Drip Tray (SPK/LS/0003) is designed for catching any liquid that may be spilled when carrying out a test. The drip tray fits around the bottom anchor pin and is clamped in place by the anchor pin, locking nut or the grip threaded adaptor.

Care should be taken not to spill any liquid onto the LS, when emptying the drip tray.



*LS machine with Optional Drip Tray and Food Testing Accessories*

## 5.3 EXTENSOMETER INTERFACE

To connect a single extensometer to the LS series test machine use adapter cable part number 09/1047 (37 way female to 25 way female).

To attach up to three extensometers to the LS series test machine use extensometer interface box assembly part number 01/3905. This interface box is powered from the LS series machine and requires no external power supply. This assembly comes with a 37 way to 37 way cable that goes from the rear of the LS series test machine to the interface box. The interface box is fitted with three 25 way D sockets on the front of the box and these are used to connect one, two or three extensometers to the LS series test machine. The sockets can be used in any order because each extensometer has a unique identity and is selected either using the LS series control console or the NEXYGENPlus 3 software console.



## 6.0 CONTROL CONSOLES

### 6.1 MAIN CONTROL CONSOLE DESCRIPTION

The unit has a Liquid Crystal Display (LCD) to show set-up information, load and extension values etc. and a key pad to input information for operating the machine when under control of the console. The machine is set up by answering simple questions and entering information when requested. The operating status of the machine is shown and described on the display.



*LS Control Panel*

## 6.2 KEYPAD OPERATION AND DESCRIPTION

The keypad has 25 keys arranged into 4 groups.

The first group contains 8 keys in the bottom right hand corner of the keypad

The First Group of Keys

**GO** The GO button is used to start a test from the machine console and is operable from the "Pre-Test" display.

**STOP** The STOP key is used to stop a test that is being performed from the machine console, e.g., if the machine does not stop automatically or the user requires to abort the test. This is not an Emergency Stop Button. The Emergency Stop Button (Mushroom) is located on the left of machine base and can be used to stop the machine in an emergency situation.

**JOG** UP and DOWN These two keys allow the crosshead to be moved slowly into position when loading and removing samples. They are available when a test is not being performed and only operate whilst pressed. The crosshead will run at a user pre-set jog speed (a set-up option).

**FAST JOG UP and DOWN** These two keys allow the crosshead to be moved at a fast speed and therefore it is essential to ensure there are no obstructions. These keys should only be used for moving large distances and not for final adjustment when the grips are close together. They are available when a test is not being performed and only operate whilst pressed.

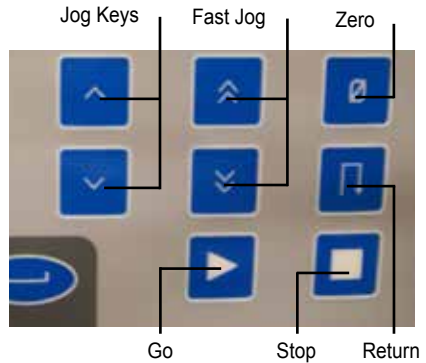

**NOTE:** The STOP key is not to be used for EMERGENCY STOP conditions. The Emergency Stop key is located on the left-side of the machine base.

**ZERO** Pressing this key sets the load and extension values to zero. This is normally carried out at the start of a test but can be used at any time when not performing a test. If Auto Zero was selected in the set-up routine the system will automatically zero when GO is pressed.

**RETURN** Pressing this key returns the crosshead to the position where the zero button was last pressed. The crosshead will move at maximum speed. The return button is available when a test is not being performed.

The second group contains 4 keys directly below the display. These “Soft Keys” are used to select various options that are identified by the text displayed on the lower lines of the display as described later.



*Dynamic Function Keys Mapped to Displayed Information*

#### ALPHA-NUMERIC KEYS

contains 12 keys on the left hand side of the keypad. These keys are used to enter text or numbers and are labelled 1 to 9, 0, decimal point and negative sign. Most keys also double up as alphabetical entry keys similar to the style used on mobile phones.



*Alpha-numeric Keys*

#### ENTER KEY

This key is the ENTER key which is used to accept any entered text, value or unit. It is also used to accept the entries on a completed display and to show the PREVIOUS display. The ENTER key is not available when a test is being performed or when input from another key is required.



*ENTER Key*

### 6.3 THE DISPLAY

The display, which has 4 lines of 40 characters, is used to show or request information. The information displayed depends upon the status of the machine but generally, the top line displays a title or help information for each display. The lower lines are split into 4 blocks, one block above each Soft Key, to indicate the function of that key.

### 6.4 "SWITCH-ON" DISPLAY

When first switched on the display will be blank while the system performs some routine checks.

After a few seconds the display will show information about the machine and the version of the embedded software installed. Similar to the one shown below.

```

LLOYD INSTRUMENTS LTD
LS Materials Testing Machine
Version TBD
Load Cell 001234 N

```

This information is displayed for three seconds after which the test selection screen is displayed.

The next display shows that a test called CYCLE\_TEST has been defined. The number in brackets shows the number of sample results currently stored with this test.

```

Select the required test
CYCLE_TEST (150 Samples)
Test      <      >      Edit

```

A total of 600 sample results can be stored across all test set-ups. If the total number of samples currently stored with all the test set-ups exceeds 500 then the third line will display a warning message.

```

Select the required test
CYCLE_TEST (501 samples)
Warning: Only space for 99 more samples
Test      <      >      Edit

```

As the left and right arrow ( < > ) Soft Keys are pressed, the names of the previously defined tests will be shown.

When the first test is displayed, the left arrow will be hidden as shown below.

```

Select the required test
LIMIT_TEST (150 samples)
Test      <      >      Edit

```

When the last test is displayed, and less than 10 set-ups have been defined the display below will be shown.

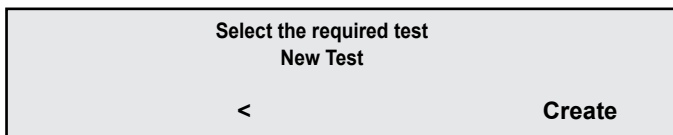

To define a test, refer to Section 9.0 SETTING UP A NEW TEST, noting that the supervisor may add a password to prevent the operator from entering the EDIT or CREATE modes.

## 6.5 HANDHELD REMOTE CONTROL

The handheld remote control is used when NEXYGEN™ software is being used to control the LS test machine. The handheld remote control has a small display that indicates the load and distance of the machine.

**GO** The GO button is used to start a test from a NEXYGEN*Plus* autotest program.

**STOP** The STOP key is used to stop a test that is being performed from the NEXYGEN*Plus* software, e.g., if the machine does not stop automatically or the user requires to abort the test. This is not an Emergency Stop Button. The Emergency Stop Button (Mushroom) is located on the left of machine base and can be used to stop the machine in an emergency situation.

**JOG** UP and DOWN These two keys allow the crosshead to be moved slowly into position when loading and removing samples. They are available when a test is not being performed and only operate whilst pressed. The crosshead will run at a user pre-set jog speed (a set-up option).

**FAST JOG UP and DOWN** These two keys allow the crosshead to be moved at a fast speed and therefore it is essential to ensure there are no obstructions. These keys should only be used for moving large distances and not for final adjustment when the grips are close together. They are available when a test is not being performed and only operate whilst pressed.

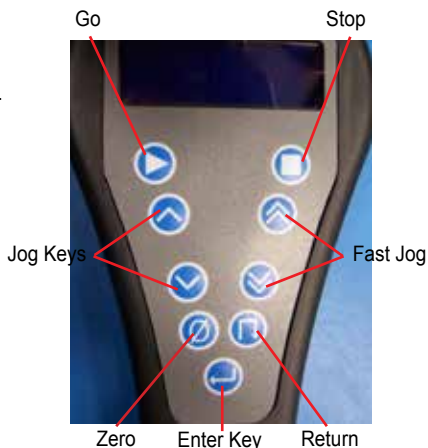

**ENTER** The enter key is used to clear error messages from the hand remote display.

**ZERO** Pressing this key sets the load and extension values to zero. This is normally carried out at the start of a test but can be used at any time when not performing a test. If Auto Zero was selected in the set-up routine the system will automatically zero when the test is started.

**RETURN** Pressing this key returns the crosshead to the position where the zero button was last pressed. The crosshead will move at maximum speed. The return button is available when a test is not being performed.

## **6.6 DISPLAYED UNITS ON HANDHELD REMOTE CONTROL**

The handheld remote control can display the load and extension values in 1 of 3 combinations:

N and mm  
kgf and mm  
lbf and in

To change the displayed units, press ZERO key 2 times when "Lloyd Instruments" is displayed immediately after the machine is switched on

The displayed units will change in sequence:

If N and mm is displayed, these will change to show kgf and mm  
If kgf and mm is displayed, these will change to show lbf and in  
If lbf and in is displayed, these will change to show N and mm

## 7.0 OPERATIONAL PRECAUTIONS

### 7.1 SAFETY

LLOYD INSTRUMENTS testing machines are inherently safe if used properly. Operators must be made aware that:-

- 1 High physical forces are involved.
- 2 Samples under test may shatter.
- 3 Electrical power supplies are involved.
- 4 The following must **ALWAYS** be brought to the attention of any operator before they are allowed to use the machine. Hands, fingers and other parts of the body must at all times be kept well away from the moving crosshead. Operators should be particularly careful when moving the crosshead to insert test samples, to ensure that no part of the hand could be accidentally compressed as the crosshead and grips are jogged into position.
- 5 **NEVER** drive the machine from a computer when anyone else is working on or near the machine.
- 6 If there is any danger that liquids may be spilt during tests, operators must use a drip tray (which is available from LLOYD INSTRUMENTS) to guard against the possibility of any spillage entering the machine and giving rise to electrical or other hazards.
- 7 Take extra care when operating in compression mode where specimens may burst, shatter or fly out from between the platens. Operators should STAND CLEAR during testing. Splinter shields are available in various options to suit specific requirements.
- 8 All operators must receive adequate training in basic operation before being allowed to use the machine. Additional copies of this manual are available from AMETEK Inc.
- 9 Operators must ensure that the Emergency Stop Button is never obstructed.
- 10 Operators must ensure that other personnel working in or near the area are made aware that testing is taking place and that they should not approach the machine while it is in use.
- 11 Operators must ensure that the machine is regularly serviced and calibrated by LLOYD INSTRUMENTS, or one of their accredited service dealers.
- 12 To maintain EMC compatibility, the machine should only be used as prescribed in this manual. Connecting cables, plugs and sockets should be inspected regularly. Cables damaged or worn in any way should not be used. Accessories and accessory connecting leads, if suspect, should be replaced only with a LLOYD INSTRUMENTS approved replacement. Failure to observe this may cause your machine to infringe the EMC legal requirements.
- 13 **NEVER** attempt any form of machine maintenance without disconnecting the mains electrical supply.
- 14 **NEVER** attempt to test any samples with a type of grip or other accessory, which is not designed for that particular test. Never use grips or the machine for tests in excess of the stated load limits. A comprehensive range of alternative grips, together with an applications advisory service, is available from LLOYD INSTRUMENTS and their accredited dealers.



### 7.2 EMERGENCY STOP

If for any reason, the machine needs to be stopped without delay, an emergency stop mushroom switch is provided. Pressing the switch stops the LS machine immediately. It can be released by turning a quarter-a-turn clockwise. The machine will then go to the initialized/start-up sequence if the ON/OFF switch is already ON.



*Emergency Stop Switch*

### 7.3 SPLINTER SHIELDS

A transparent splinter shield (part number 01/3909) is available as an option to enclose the test sample. The shield should be fitted if there is any danger of samples shattering during the test. The shield has an electronic interlock such that the test cannot be started until the hinged shield is closed.

If a shield fitted with electronic interlock is used, the following screen will appear if the door is opened during a test.

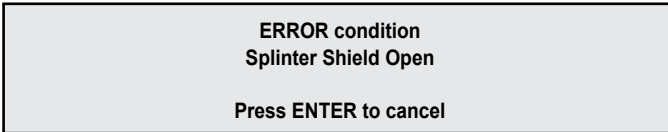

The test in progress will be aborted and the next test or a new test will have to be started.



## 7.4 LOWER ANCHOR PIN ADJUSTMENT

The Lower Anchor Pin can be adjusted to align itself with the attached load cell. To align the load cell to the lower anchor pin lower the load cell on to the moving ram so that it is very close to the lower anchor pin using the jog keys. Loosen the anchor nut using the spanner wrench provided. Loosen the 4 set screws using a 2.5mm hex key. Align the lower anchor pin to the load cell anchor pin and then re-tighten the 4 set screws so that the two anchor pins are properly aligned with each other. Re-tighten the anchor nut using the spanner wrench.

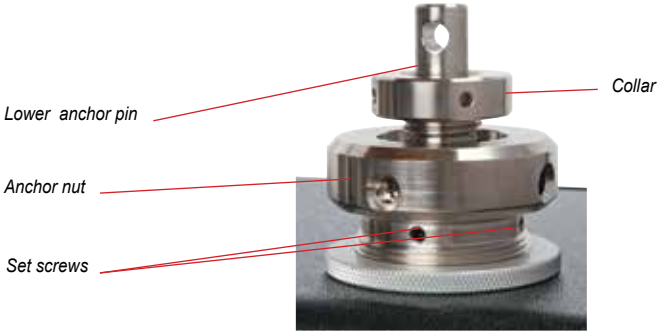

*Lower Anchor Pin Locking Collars*

The collar is used to secure the lower grip in place. Use the spanner wrench provided to secure the lower grip to the collar as shown below.



Extreme care must be taken when manoeuvring the crosshead, particularly when low force load cells are being used as they can easily be damaged even at moderate speeds. As an additional precaution during compression testing the lower (hardware) limit stop should be set so that the compression plates cannot come together either during or after a test.

## 7.5 LIMIT STOPS

The LS machines are fitted with two mechanically activated limit stops. These can be used as extra protection to stop load cells, grips or fixtures coming into contact. The upper one can be used to back up the software limit. Activating a limit stop will result in the machine stopping.

To adjust the lower limit stop, first loosen the lower limit stop screw and move the stop to the bottom of its travel in the slot. Drive the moving crosshead to the lowest position that it may go to safely, without damaging any fitted grips or fixtures. When this position has been reached, drive the crosshead up by 3mm (0.125 inch). Move the lower adjustable limit stop up until it stops against the crosshead actuator within the column. Tighten the screw in this position. Ensure the screws are free to move vertically to actuate the switches.

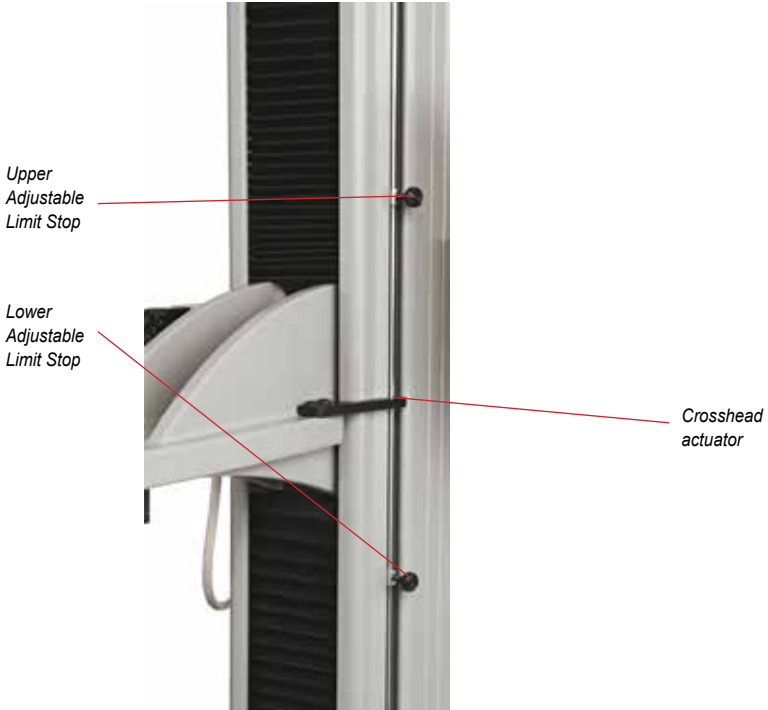

*LS Machine Showing Mechanical Limit Switches*

To adjust the top limit stop, loosen the upper limit stop screw and move the screw to the top of its travel and tighten the screw temporarily in this position. Drive the moving crosshead to the highest position it may go to safely, without damaging any fitted grips or fixtures. When this position has been reached, drive the crosshead down by 3mm (0.125 inch). Loosen the upper limit stop screw and move the screw down to the limit stop cross head actuator and tighten the screw in this position. Once again, ensure the screws are free to move vertically to actuate the switches.

If during a test or when manoeuvring the crosshead, a limit stop switch is activated, a display as shown below or similar will be seen.

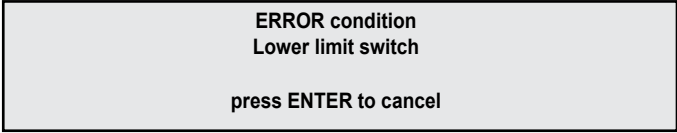

When ENTER has been pressed and this display has been cleared the machine will only allow the operator to drive the crosshead away from the limit stop.

## **8.0 PERFORMING A TEST**

### **8.1 PERFORMING A TEST**

The LS machines can be used to perform tests in two modes, as a stand-alone machine or under computer control with NEXYGEN*Plus*™ software.

If the machine is to be used with a computer and NEXYGEN*Plus*™ software, then the NEXYGEN-*Plus*™ Software User Manual supplied with the software, should be read in conjunction with this manual. The machine should be connected to the computer with the USB lead supplied. When the machine is on and ready, the computer connected with the lead supplied, and NEXYGEN*Plus*™ running, connection between the machine and computer is automatic.

If the LS machine is being used in “stand alone” mode, proceed as follows. The following information will also be needed for “setting up” the machine with grips, samples etc.

### **8.2 TEST PARAMETERS**

#### **SAMPLE PREPARATION**

The Jog Keys are used to prepare for a test. The accessories being used will be dependent on the type of test being conducted.

#### **LOAD CELLS**

The correct load cell should be fitted in the machine for the application being undertaken. Great care should be taken with these as they are precision measurement devices and can be damaged if used incorrectly. Please make sure that you have read Section 4.3 carefully before proceeding further.

#### **GRIPS/ADAPTORS**

It is important that grips are fitted along the central straining axis of the machine and that no side loads are applied to the load cell as this will affect the accuracy of the load readings. The grips should be connected to the load cell and the bottom anchor pin or fixture using only the pins and parts provided. Care should be taken not to exceed the load rating of the grips. It is important to ensure that the grips used are suitable for the material under test. Any slippage of the material in the grips will affect both load and extension readings.

#### **EXTENSOMETERS**

It is important to understand that the extension that the crosshead moves does not give a true reading of the strain in the samples. If we consider a dumbbell sample for instance, the strain will be different at different positions along the sample and no account is being taken of the take up of slack or bedding in of the grips. For accurate strain readings we would strongly recommend the use of a LLOYD INSTRUMENTS extensometer, which is suited for the material under test.

### 8.3 SELECTING A TEST

The user selects the required existing pre-programmed test by pressing the left and right arrow Soft Keys until the required test is shown on the display, then pressing the Test Soft Key.

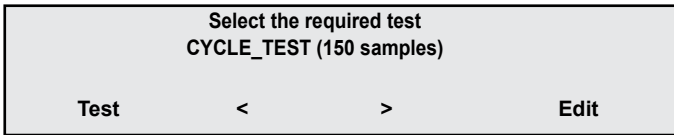

Depending on how the test has been set up one or more of the following screens will be displayed. Refer to **Section 9.0 SETTING UP A NEW TEST** for details on setting these options.

If an external extensometer has been selected for use then the following screen will be displayed if the required extensometer is not fitted.

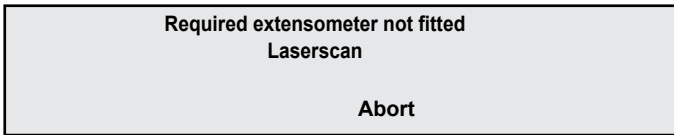

If the external extensometer is fitted but has a selectable range the following screen will be displayed.

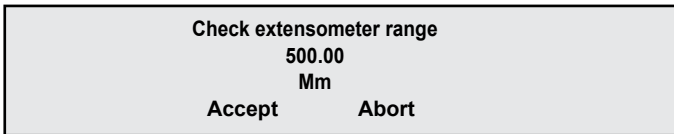

The external extensometer range must be set to the range displayed on this screen for the measurement of extension to be correct.

If a plotter output has been selected and a plotter interface box connected then the following screen will be displayed.

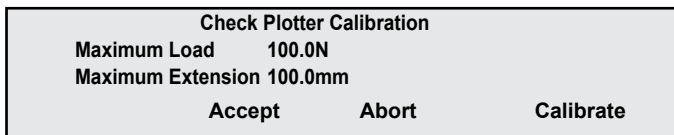

Pressing the Calibrate Soft Key allows the user to the following screen

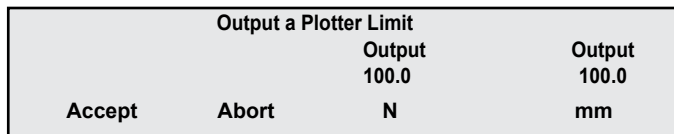

If the batch questions option is turned on, then the following screen will be displayed. A “batch” being a series of tests all carried out with the same settings. The “batch questions” are 3 two word questions which can be set-up at the beginning of a new “batch”

<b>Press a key to change a parameter</b>	
<b>OPERATOR</b>	<b>BATCH</b>
<b>NAME</b>	<b>NUMBER</b>
<b>Suspend</b>	

The information can only be entered when a new batch is started i.e. when sample number 1 is to be tested. The operator can answer the questions by pressing the Soft Key below each question.

Pressing the **Enter** key will confirm all the answers to the batch questions and show the pre-test display.

If the operator is continuing with a previously suspended batch, then the batch questions, and their answers, will be displayed in a “view only” mode.

<b>OPERATOR</b>	<b>DAVE</b>
<b>BATCH NUMBER</b>	<b>B21_G</b>
<b>Continue</b>	<b>Suspend</b>

Here the operator will be given the option to Continue with the previously suspended batch or to Suspend the batch again by pressing the appropriate Soft Keys.

<b>Press GO to test Sample 1</b>			
<b>6.00mm x 3.00mm</b>		<b>MOULD_32</b>	
<b>Ext ↑ 10.00mm</b>		<b>Load ↑ 276N</b>	
<b>Sample</b>	<b>Stats</b>	<b>Reset</b>	<b>Suspend</b>

On the top line of the Pre-test display help information is shown. On the second line, the right hand side shows the test setup name.

On the third line, Extension and Load are displayed.

The extension symbols  $\uparrow$  or  $\downarrow$  indicate the direction of the extension from the “soft zero” position. “Soft zero” being the position at which the ZERO key was last pressed.

The load symbols  $\uparrow$  or  $\downarrow$  indicate a Tensile Force or Compressive Force, respectively.

If the sample questions option is turned on, then next to the test name the sample width and thickness, diameter or area information will be shown. The Sample Soft Key will also be displayed. Refer to Section 9.0 SETTING UP A NEW TEST for details on setting these options.

Pressing the **Suspend** Soft Key returns to the test selection display but saves the statistics and last sample number ready to continue the batch later.

Pressing the **Reset** Soft Key resets all the batch results, sets sample number to 1 and shows the display that would be selected when first selecting the test, i.e. batch or pre-test. This is only done after confirmation by the operator.

Pressing the **Stats** Soft Key will show the statistics for the samples tested so far and allow them to be printed.

Pressing the **Sample** Soft Key will display the sample question screen shown below.

Press a key to change a parameter			
Gauge	Width	Thickness	SAMPLE NUMBER
25.00	6.00	3.00	
mm	mm	mm	

This display allows the operator to enter the sample dimensions and a single description. The text for the 3 sample fields depends upon the test mode and sample type. The first field will say **Gauge** for Tension or **Height** for Compression. The second field will say Width for Rectangular, **Diameter** for Circular or **Area** for Area.

The third field will only be displayed for Rectangular samples and will say **Thickness**. The fourth field will display the sample question defined in the test setup. The Soft Keys allow the sample dimensions to be altered and the sample question to be answered.



### 8.4 STARTING A TEST

When all the test parameters have been set as per 8.3 SELECTING A TEST above, press GO to start the test and display one of the screens below.

For a Limit Test:

Performing Test	MOULDED_RUBBER
Moving to limit point	
Ext ↑ 10.00mm	Load ↑ 276N

or for a Cycling Test

Performing Test	MOULDED_RUBBER
Moving to limit point. Cycle 3	
Ext ↑ 10.00mm	Load ↑ 278N

The LS is supplied with three pre-defined test setups and one for new test setups, these are:-

LIMIT\_TEST, CYCLE\_TEST, BREAK\_TEST, NEW\_TEST

These are described in section 9.1 PRE-DEFINED TEST SETUPS.

### 8.5 STOPPING A TEST

When the test ends, either automatically or if the user presses the **STOP** key, the post test screen will be displayed

Sample 1 Passed			
Pk Load 367N		Brk Load 237N	
Pk Ext 126.50mm		Brk Ext 157.80mm	
Print	Stats	Accept	Cancel

This screen will display different amounts of information depending on how the test has been set up. Refer to Section 9.0 SETTING UP A NEW TEST for details on setting these options.

### 8.6 PRINTING TEST RESULTS

Pressing the **Print** Soft Key will either print just the single result or, if **All** was selected for the **Sample Printout** option in the test setup, together with the machine setup details, i.e. test speed etc.

### 8.7 CANCELLING OR ACCEPTING THE RESULTS

Pressing the **Cancel** Soft Key will cancel the result (abort) and remove the result from the batch.

Pressing the **Accept** Soft Key or the **ENTER** key will accept the results and add them to the batch.

## 8.8 VIEWING THE STATISTICS

Pressing the **Stats** Soft Key will accept the result and show the statistics screen as below:-

	Pk Load	Pk Ext	
Mean	367N	126.57m	
Dev'n	5N	24.18mm	
Print			>

Pressing > Soft Key will show the second statistics screen:-

	Brk Load	Brk Ext	
Mean	137N	155.03m	
Dev'n	12N	54.13mm	
Print			<

Pressing the **Print** Soft Key from the statistics screen will show the 'print options' screen shown below:

<b>Stats Only</b>	<b>Brief Report</b>	<b>Full Report</b>
-----------------------	-------------------------	------------------------

Pressing the **Stats Only** Soft Key will give a table of statistics only, without the test value.

Pressing the **Brief Report** Soft Key will give a table of test values and statistics.

Pressing the **Full Report** Soft Key will give a table of test values, statistics and test setup information.

## 8.9 ERROR CONDITIONS

If an error condition exists the cause of the error will be shown on the display. This error must be cleared before you can proceed with the test. See **Section 10.1** for details of error messages

## **9.0 SETTING UP A NEW TEST**

### **9.1 PRE-DEFINED TEST SETUPS**

The LS is supplied with three pre-defined test setups and one for new test setups, these are:

LIMIT_TEST	A test which is carried out to a limit. The limits are defined in mm or inches, % elongation (after setting gauge length), Newtons, Kg force, lbs force, Mega Pascal's Mpa (have entered the sample dimensions), Kg force per mm <sup>2</sup> and lb force per inch <sup>2</sup>
CYCLE_TEST	A cycle is from home to a limit (as set out above) and back to home. If when the test starts the crosshead is not at the home position, it will move to the home position first before going to the limit position. The machine can be set to perform up to 10000 cycles per test.
BREAK_TEST	A Break Test will either, stop at a limit as described above or when a break is detected. There are 2 types of break detector. A % break detector which detects when the load has dropped to 50% of the maximum peak load detected and sharp break detector. The sharp break detector operates when there has been a sharp change in load or direction between one load reading and the next.
NEW_TEST	Is a user defined test rather than one of the default settings which are detailed on the next page.

The Default test setups are as follows:

Test name >	LIMIT_TEST	CYCLE_TEST	BREAK_TEST	NEW_TEST
<b>Test Type</b>	<b>Settings</b>			
Test mode	Tension	Tension	Tension	Tension
Test type	Limit	Cycling	Limit	Limit
Limit position	10.0mm	10.0mm	N	10.0mm
Home position		0.0mm		
No. of cycles		10		
Preload	0.0N	0.0N	0.0N	0.0N
Speed	100mm/min	100mm/min	25mm/min	250mm/min
Hold	0 seconds			0 seconds
Machine Stiffness Compensation	Disabled	Disabled	Disabled	Disabled
<b>Test Options</b>				
Sharp Break detector	off	off	on	off
% Break Detector	off	off	off	off
Return to zero	manual	Manual	manual	Manual
Zero readings	manual	Manual	manual	Manual
Sample printout	All	All	All	All
Extensometer Used	Internal	Internal	Internal	Internal
<b>Test Results</b>				
Peak Load	N	N	N	N
Extens'n at peak load	mm	mm	mm	Mm
Break load	N	N	N	N
Extension at Br'k load	mm	mm	mm	Mm
Pass/fail Checks	off	off	off	off
<b>Define Sample</b>				
Sample type	Rectangular	Rectangular	Rectangular	Rectangular
Gauge	25.00mm	25.00mm	25.00mm	25.00mm
Width	6.00mm	6.00mm	6.00mm	6.00mm
Thickness	3.00mm	3.00mm	3.00mm	3.00mm
1st Batch ? line 1	OPERATOR	OPERATOR	OPERATOR	OPERATOR
1st Batch ? line 2	NAME	NAME	NAME	NAME
2nd Batch ? line 1	BATCH	BATCH	BATCH	BATCH
2nd Batch ? line 2	NUMBER	NUMBER	NUMBER	NUMBER
3rd Batch ? line 1				
3rd Batch ? line 2				
Sample ? line 1	SAMPLE	SAMPLE	SAMPLE	SAMPLE
Sample ? line 2	ID	ID	ID	ID
Batch questions	off	off	off	off
Sample questions	off	off	off	off

## 9.2 DEFAULT GLOBAL SETTINGS

The Default Global Settings are:

Field	Setting
Password	<None>
Safety load	50N
Slow jog speed	25mm/min
Data format	Printer
Grip protection Tension	110% of frame rating
Grip protection Compression	110% of frame rating
Language	English

To enter a New Test Setup or Edit a pre-defined setup, proceed as follows.

## 9.3 EDITING A PRE-DEFINED TEST SETUP

To edit a previously defined test setup, select the required test, using the left and right arrow keys, until the required test is displayed then press the Edit Soft Key.

This is the Select/Edit Display.

<b>Select the required test</b> <b>CYCLE_TEST (150 samples)</b>			
<b>Test</b>	<	>	<b>Edit</b>

## 9.4 PASSWORD ACCESS

If the machine has been given a password, the password entry display will be shown.

<b>Enter the password to edit this test</b>	
<b>BkSp</b>	<b>Clear All</b>

Type the password then press the ENTER key .

If the password is not correct, the test Select/Edit Display will be redisplayed.

If the password is correct, the main setup display is shown.

This is the Main Setup Display

<b>Press a key to select an option</b> <b>CYCLE_TEST</b>			
<b>Rename</b>	<b>Global</b>	<b>Delete</b>	<b>Setup</b>

Pressing the ENTER key will return to the Select/Edit display.

### 9.5 RENAMING A TEST

Pressing the **Rename** Soft Key will allow the setup name to be changed. If a new test is created, the name will be automatically set to new\_test.

### 9.6 DELETING A TEST

Pressing the **Delete** Soft Key will allow the selected test setup and all associated sample results to be deleted. The following screen will appear.

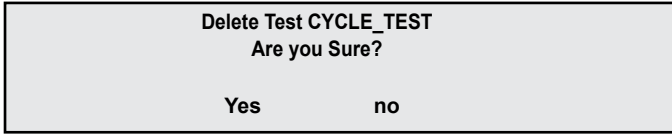

### 9.7 GLOBAL SETTINGS

Pressing the **Global** Soft key will allow the Password and Jog speed etc. to be changed.

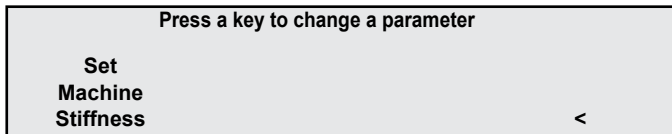
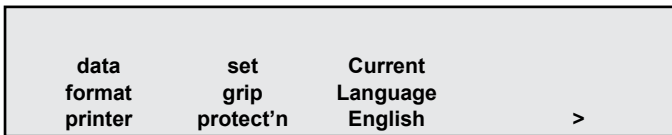
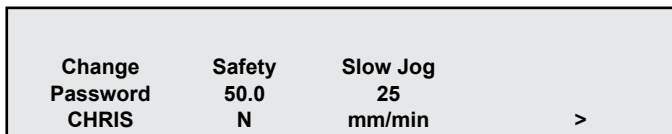

## 9.8 SETTING A PASSWORD

Pressing the Change Password Soft Key brings up the following display:

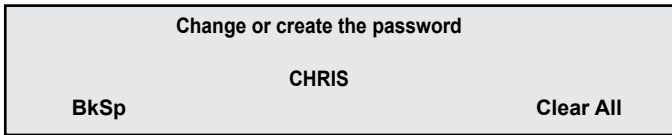

Pressing **BkSp** Soft Key deletes one character at a time starting from the right hand end of the password.

Pressing the **Clear All** Soft Key deletes all the characters.

The Alphanumeric keys add new characters to the password the **ENTER** key accepts the password as displayed.

If the password displayed is blank then there will be no password protection.

The password limits access to the edit test setup menus. If a password has been set this password will be required before any parameter of any test setup can be edited. The selection and running of previously defined test setups is not affected.

## 9.9 SAFETY LOAD LIMIT

The **Safety** limit is intended as an extra protection against accidental injury. It applies when the **JOG** keys are pressed or during return when the crosshead is moving down. Entering a high value for this option will reduce the level of safety provided and should only be done to overcome nuisance errors caused by high friction in some accessories.

## 9.10 SLOW JOG SPEED

The **Slow Jog** setting allows the user to specify the speed that the crosshead will move when the slow **JOG** keys are pressed.

## 9.11 SETTING FOR PRINTER

The **Data Format** Soft Key toggles between **Printer** and **ASCII** (ASCII for when a DATALOGGER is to be used).

## 9.12 GRIP PROTECTION SETTINGS

The **Grip Protection** setting is an additional load limit, which can be used to protect grips or accessories that are being used. The test will be stopped if the value of load exceeds the **Grip Protection** setting during a test.

## 9.13 CURRENT LANGUAGE

Pressing the **Current Language** soft key allows the user to select the language to be used from the list of languages supported by the machine. The chosen language will be used for all information presented to the user, including information output to a printer.

### 9.14 MACHINE STIFFNESS

Pressing the **SET MACHINE STIFFNESS** soft key allows the user to perform a machine stiffness compensation.

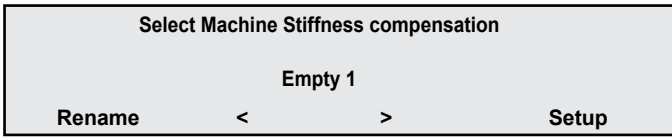

Use the < or > soft keys to select the machine stiffness compensation slot to use for the compensation. There are 10 machine stiffness compensation slots.

Use the **Rename** soft key to change the name of the current machine stiffness slot.

Use the **Setup** soft key to setup the machine stiffness compensation range and perform a machine stiffness compensation.

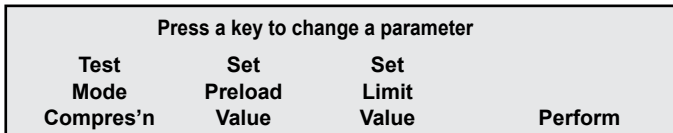

Use the **Test Mode** soft key to select Tension or Compression Machine Stiffness compensation.

Use the **Set Preload Value** soft key to set the start value for the machine stiffness compensation.



**NOTE:** It is recommended that the minimum value for the machine stiffness compensation start value (Preload) is 1% of load cell value.

Use the **Set Limit Value** soft key to set the machine stiffness compensation end value.

Use the **Perform** soft key to perform a machine stiffness compensation.

### 9.15 TEST SETUP DISPLAY

Pressing the Setup Soft Key from the Main Setup Display will show the test setup display.

This is the Test Setup Display

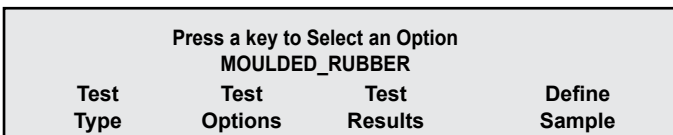



## 9.16 TEST TYPE

Pressing the **Test Type** Soft Key will allow the test type to be defined.

Press a key to change a parameter			
<b>Test Mode</b>	<b>Test Type</b>	<b>Set Limit Values</b>	<b>&gt;</b>
<b>Tension</b>	<b>Limit</b>		

Pressing the **>** Soft Key will toggle between the display above and the next display.

Press a key to change a parameter			
<b>Speed</b>	<b>Set Preload Values</b>	<b>Machine Stiffness Enabled</b>	<b>&lt;</b>
<b>150 mm/min</b>			

The **test mode** Soft Key toggles between **Tension** and **Compression**.

The **Test Type** Soft Key toggles between **Limit** and **Cycling**. In cycling mode the **Set Limit Values** Soft Key changes to Set Cycling values.

Pressing the **Set Limit Values** Soft Key will allow the values to be set.

Press a key to change a parameter			
<b>Limit</b>	<b>Hold</b>		
<b>10.00 mm</b>	<b>0 seconds</b>		

The limit type, value and unit may be set or changed by pressing the **Limit** Soft Key. The required parameters may then be entered.

If either a Hold value is set or if the units of Speed are in load rate units sample stiffness information will be displayed.

Press a key to change a parameter			
<b>Limit</b>	<b>Hold</b>	<b>Sample Stiffness</b>	<b>Initial</b>
<b>10.00 mm</b>	<b>30 seconds</b>	<b>Auto</b>	<b>100000.0 N/mm</b>

Sample Stiffness can be set to Auto (see above) or Manual (see screen below). Sample stiffness is used when a test is being carried out under load rate control, i.e. when driving at a rate of Newtons per minute or lbs per inch. The machine speed will have to vary depending on the stiffness of the sample.

Manual Sample stiffness uses the value entered throughout the test. Auto sample stiffness starts from an Initial value and throughout the test re-calculates this value.

Press a key to change a parameter			
<b>Limit</b>	<b>Hold</b>	<b>Sample Stiffness</b>	<b>Initial</b>
<b>10.00 mm</b>	<b>30 seconds</b>	<b>Manual</b>	<b>100000.0 N/mm</b>

Pressing the **Set Cycling Values** Soft Key will allow the values to be set.

Press a key to change a parameter		
<b>Limit</b>	<b>Home</b>	<b>Number of Cycles</b>
<b>20.0</b>	<b>10.0</b>	<b>2</b>
<b>mm</b>	<b>mm</b>	

The **Home** position is the start of the Cycle Test position and wherever the machine is resting after loading it will drive first to the **Home** position. After reaching the home position it will drive to the Limit position and back to the **Home** position to complete the first cycle. The machine's response to inputs as shown above is illustrated in the NEXYGENPlus™ graph shown below

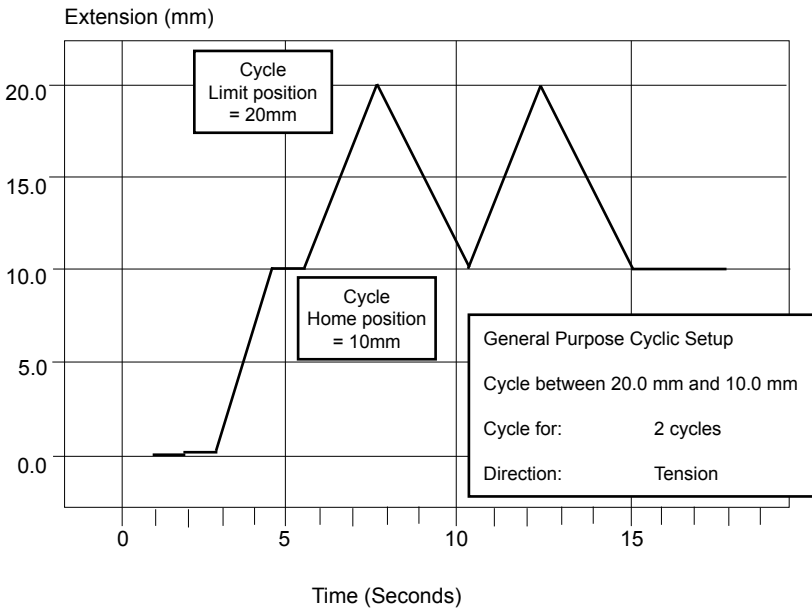

Pressing the Set Preload Soft Key will allow the values to be set. It is recommended that the minimum value entered is no less than 1% of the Loadcell value fitted.

Press a key to change a parameter	
<b>Speed</b>	<b>Limit</b>
<b>10</b>	<b>0.00</b>
<b>mm/min</b>	<b>N</b>

### 9.17 SELECTING MACHINE STIFFNESS COMPENSATION

Press a key to change a parameter			
Speed	Set	Machine	
150	Preload	Stiffness	
mm/min	Values	Disabled	<

Pressing the **Machine Stiffness** soft key enables the user to select the machine stiffness compensation to use in the current selected test setup

Press a key to change a parameter		
Empty 1		
Enabled	<	>

### 9.18 TEST OPTIONS

Pressing the Test Options Soft Key from the test setup display will allow the test options to be set.

Press a key to change a parameter			
Break			
Detector	Return	Zero	
Sharp	Auto	Manual	>

Pressing the > key will toggle between the above display and the next display.

Press a key to change a parameter		
Sample	Extenso'r	
Printout	Used	
All	LFPlus	>

If the > key is pressed the following screen will appear.

Press a key to change a parameter	
Plotter Output disabled	>

By pressing the **Break Detector** Soft Key the following display is shown

Sharp Break Detector

Press a key to change a parameter		
Sharp Break On	Percent Break Off	Start 50 N

There are two break detectors, a sharp break detector and a percentage of peak load break detector. The sharp break detector operates when there has been a sharp change in load or direction between one load reading and the next. Either break detector is turned On or Off by pressing the appropriate Soft Key. Only one break detector can be turned On at a time. When a break detector is turned On, other options are displayed. Both break detectors have a **Start** option and the **Percentage** break detector also has a Percentage Break option.

Percentage of Peak Load Break detector

Press a key to change a parameter			
Sharp Break Off	Percent Break On	Start 50 N	Break Point 50 %

The **Start** option sets the threshold above which the peak load must rise before the break detector will start operation. The **Percent Break** option sets the percentage of peak load below which the measured load must fall to constitute a break.

The **Return** and **Zero** options toggle between **Manual** and **Auto**.

Pressing the **Extensio'r Used** Soft Key will allow the selection of any extensometer currently fitted from the following screen.

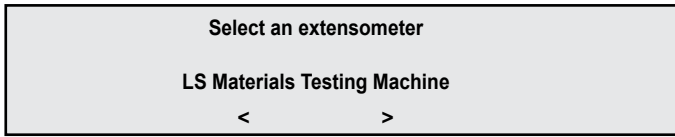

The left and right arrow ( < > ) Soft Keys will scroll through the list of currently connected extensometers, (theoretically a maximum of 4 with the internal crosshead position always being listed as one of these). The internal crosshead position extensometer is displayed as the LS materials testing machine, i.e., LS Press the **ENTER** key to select the displayed extensometer.

If the selected extensometer has a selectable range, then an additional option will be displayed in the Test Options screen.

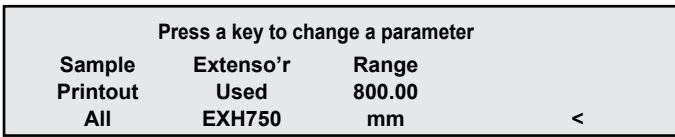

The extensometer range will default to the maximum range of the extensometer but can be changed by pressing the **Range** Soft Key.

Pressing the Sample Printout Soft Key, toggles between "Result" and "All". "Result" will print the 4 results and "All" will print the 4 results and the machine parameters.

Pressing the Plotter Output Soft Key, toggles between "Disabled" and "Enabled". In the "Enabled" position, the following screen will be displayed where the plotting parameters can be set.

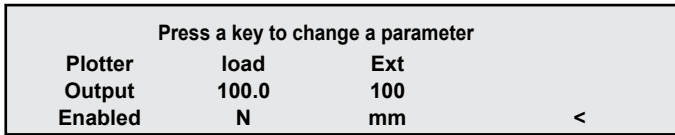

### 9.19 TEST RESULTS

Pressing the Test Results Soft Key from the Test Setup Display will allow the test results units and pass/fail limits to be set.

Press a key to change a parameter	
<b>Test Results Units</b>	<b>Pass/Fail Checks Off</b>

Pressing the **Tests Result Units** Soft Key allows the units to be set.

Press a key to change a parameter			
<b>Peak Load</b>	<b>Peak Ext</b>	<b>Break Load</b>	<b>Break Ext</b>
<b>N</b>	<b>mm</b>	<b>N</b>	<b>mm</b>

### 9.20 PASS/FAIL VALUES

If Pass/Fail is set to On, another two options are available.

Press a key to change a parameter			
<b>Test Result Units</b>	<b>Pass/Fail Checks On</b>	<b>Break Pass/Fail Limits</b>	<b>Peak Pass/Fail Limits</b>

Pressing either the **Break Pass/Fail limits** or **Peak Pass/Fail** Soft Keys will allow the values to be set.

Break pass/fail values

Press a key to change a parameter			
<b>Max Load</b>	<b>Min Load</b>	<b>Max Ext</b>	<b>Min Ext</b>
<b>5000</b>	<b>100</b>	<b>250.00</b>	<b>100.00</b>
<b>N</b>	<b>N</b>	<b>mm</b>	<b>mm</b>

### 9.21 DEFINING SAMPLE

Pressing the **Define Sample** Soft Key from the **Test Setup Display** will allow the sample/batch details to be set.

Press a key to change a parameter			
<b>Sample Info</b>	<b>Pre-test Questions</b>	<b>Batch Questions Off</b>	<b>Sample Question Off</b>

The **Batch Questions** and **Sample Question** Soft Keys toggle between **On** and **Off** to specify which pre-test question displays will be shown.

Pressing the **Sample Info** Soft Key will allow the sample details to be defined.

Press a key to change a parameter			
<b>Sample Type</b>	<b>Gauge</b>	<b>Width</b>	<b>Thickness</b>
<b>Rect'r</b>	<b>25.00</b>	<b>6.00</b>	<b>3.00</b>
	<b>mm</b>	<b>mm</b>	<b>mm</b>

Pressing the **Sample Type** Soft Key toggles between **Rect'r / Circular / Area**. The titles **Gauge**, **Width** and **Thickness** depend upon the test mode and the sample type. The title **Gauge** becomes **Height** for Compression. The title **Width** becomes **Diameter** for Circular or **Area** for Area. The title **Thickness** is only displayed for **Rect'r**.

### 9.22 PRE-TEST QUESTIONS

Pressing the **Pre-test Questions** Soft Key allows the pre-test questions to be defined. The Batch questions come at the beginning of the batch and help define the batch. The **SAMPLE** question comes up before each sample in a batch and helps identify each sample

Press a key to change a parameter			
<b>Batch 1</b>	<b>Batch 2</b>	<b>Batch 3</b>	<b>Sample</b>
<b>OPERATOR</b>	<b>BATCH</b>		<b>SAMPLE</b>
<b>NAME</b>	<b>NUMBER</b>		<b>NUMBER</b>

Up to 3 batch questions and 1 sample question may be defined.

## **10.0 ERROR CONDITIONS**

### **10.1 ERROR CONDITIONS**

On the LS, if an error occurs, a message will be displayed on the console describing the error. This message must be cleared by pressing the ENTER key before proceeding. Some errors are displayed when the machine is first powered on and indicate faults that were detected during the power up sequence.

If the LS machine is being used with a computer and NEXYGENPlus™ software, similar messages will be displayed on the computer by NEXYGENPlus™.

The ERROR messages are as follows:

#### **Data Packet Error**

This error indicates that an invalid data packet has been received across the USB interface. All data transferred via USB is checked for errors and resent if any error occurs, so this message should never be displayed. If it is seen it is indicative of other problems occurring either within the machine or at the PC.

#### **Motor Drive Fault**

This indicates that the motor drive system has reported an error condition.

#### **Upper limit switch**

The adjustable upper limit switch has been hit. This can be cleared by adjusting the upper limit or driving off it using the jog down keys.

#### **Lower limit switch**

The adjustable lower limit switch has been hit. This can be cleared by adjusting the lower limit, or driving off it using the jog up keys.

#### **No Loadcell Available**

An attempt has been made to drive the machine without a load cell connected. Ensure the load cell is properly connected and try again.

#### **Splinter Shield Open**

The splinter shield fitted to the machine is open. A test cannot be started until the splinter shield is closed.

#### **Cell Overload**

The load applied to the system is in excess of 110% of the load cell rating. Use the jog keys to remove the load.

#### **Safety Overload**

The load applied to the load cell is in excess of the safety load limit in the global settings. This limit only applies when the crosshead is moving downwards during return or under control of the jog keys.

#### **Frame Overload**

The load applied to the system is in excess of 105% of the frame rating. Use the jog keys to remove the load.

#### **Grip Overload**

The load applied to the system is in excess of the grip protection limit in the global settings. This limit only applies during a test.

#### **Print unavailable. Power down and retry**

An attempt has been made to print when the USB port is in use with a PC running NEXYGENPlus™. After using the machine with NEXYGENPlus™, it is necessary to power down before it is possible to print.



**Unexpected reset code XX****Unexpected software reset code XXX****Software reset code 106 (XXXXXX)**

These messages indicate that an internal error has caused the system to reset unexpectedly. Please make a note of the readings and contact LLOYD INSTRUMENTS Technical Support for help.

**System Hardware Error**

An error has occurred in the internal electronics of the system.

**Drive System Error**

The motor control system has not been able to maintain adequate control of the motor and has shut down as a safety precaution. This will usually indicate a fault within the motor drive or extension measurement system.

**Accessory Connected/Disconnected**

An accessory has been connected or removed while the crosshead is being driven.

**Load / Speed / Rating Exceeded**

The machine has moved outside the load and speed rating of the machine. Ensure the test being performed is within the machine's load and speed rating

**Extensometer Range Exceeded**

The machine has moved outside the range of the extensometer. Ensure the test being performed is within the range of the extensometer.

LS1 Error reporting	
Small Console	Large Console / PC
Error Number	Error Message
0	Data Packet Error
1	Motor Drive Fault
2	Upper Limit Switch
3	Lower Limit Switch
4	Safeline Open
5	No Loadcell
6	Splinter Shield Open
7	Cell Overload
8	Safety Overload
9	Frame Overload
10	Grip Overload
11	Print unavailable. Power down and retry
12	Unexpected reset code 01
13	Unexpected reset code 02
14	Unexpected reset code 04
15	Unexpected reset code 08
16	Unexpected reset code 10
17	Unexpected reset code 20

18	Unexpected reset code 40
19	Unexpected reset code 80
20	Unexpected software reset code 100
21	Unexpected software reset code 101
22	Unexpected software reset code 102
23	Unexpected software reset code 103
24	Unexpected software reset code 104
25	Unexpected software reset code 105
26	Software reset code 106 (000000)
27	Loadcell calibration due
28	System Hardware Error
29	Drive System Error
30	Crosshead on final limit switch
31	Accessory Connected/Disconnected
32	Load/Speed Rating Exceeded
33	Extensometer Range Exceeded
34	Stiffness Enabled Wrong Loadcell Fitted
35	Cell Overload Tension
36	Cell Overload Compression
37	Stop key pressed
38	Loadcell Reference Error

## 11.0 CLEANING AND MAINTENANCE

### 11.1 CLEANING EXTERNAL FINISH AND TRIM

The finish and appearance of your machine can be maintained by regular cleaning with a damp cloth containing a small amount of mild detergent. The machine should be turned OFF and disconnected from the mains supply whilst cleaning is taking place. Strong proprietary cleaners and petroleum based or other solvents should not be used.



**CAUTION:** Take care to use only a damp cloth. NO moisture must ever be allowed to get into the machine. Wipe the machine dry before connecting to the mains supply and restarting.

### 11.2 MAINTENANCE

In normal use and conditions, your machine should be serviced and calibrated annually by LLOYD INSTRUMENTS or one of their appointed agents. There are no user serviceable or adjustable parts within the machine, therefore service and calibration should only ever be undertaken by engineers trained for the task.

If the machine is being used in a particularly arduous way or under extreme conditions, your appointed service agent may recommend more frequent calibration/service.

## 12.0 TECHNICAL SPECIFICATION

### 12.1 TECHNICAL SPECIFICATION LS1 STANDARD TRAVEL

Maximum Force (Tension and Compression)	1000N (225lbf)
Crosshead Travel Between Eye Ends	500mm (19.7in)
Throat Depth	180mm (7.1in)
Displayed Distance Resolution	0.01mm (.001in)
Crosshead Speed Range	0.01 to 2032mm/min (0.001-80in/min)
Crosshead Speed Accuracy - Unloaded	+/-0.2% of Selected Speed - 2% to 100% of Max Speed
Load Cell Force Accuracy	+/-0.5% of Reading - 1% to 100% of Max Force
Internal Data Sampling Rate	8000Hz (8000 samples per second)
Data Transfer Rate Using NEXYGEN <i>Plus</i> ™	1000Hz (1000 samples per second)
Operating Temperature	5°C to 35°C (40°F to 95°F)
Relative Humidity	20% to 85% (Non-Condensing)
Supply Voltage	115+/-10%VAC or 230+/-10%VAC
Supply Frequency	50-60Hz
Power Rating	115VAC @ 3.15A or 230VAC @ 3.15A
Fuses (2) for 115VAC & 230VAC Units	T3A15H250V (3.15A Slow Blow Ceramic)
Frame Deflection at Maximum Force	1.4mm (0.055in) Maximum
Weight of Machine	52kg (115lb)

### 12.2 TECHNICAL SPECIFICATION LS1 EXTENDED TRAVEL

Maximum Force (Tension and Compression)	1000N (225lbf)
Crosshead Travel Between Eye Ends	800mm (31.5in)
Throat Depth	180mm (7.1in)
Displayed Distance Resolution	0.01mm (.001in)
Crosshead Speed Range	0.01 to 2032mm/min (0.001-80in/min)
Crosshead Speed Accuracy - Unloaded	+/-0.2% of Selected Speed - 2% to 100% of Max Speed
Load Cell Force Accuracy	+/-0.5% of Reading - 1% to 100% of Max Force
Internal Data Sampling Rate	8000Hz (8000 samples per second)
Data Transfer Rate Using NEXYGEN <i>Plus</i> ™	1000Hz (1000 samples per second)
Operating Temperature	5°C to 35°C (40°F to 95°F)
Relative Humidity	20% to 85% (Non-Condensing)
Supply Voltage	115+/-10%VAC or 230+/-10%VAC
Supply Frequency	50-60Hz
Power Rating	115VAC @ 3.15A or 230VAC @ 3.15A
Fuses (2) for 115VAC & 230VAC Units	T3A15H250V (3.15A Slow Blow Ceramic)
Frame Deflection at Maximum Force	1.6mm (0.063in) Maximum
Weight of Machine	62kg (137lb)

### 12.3 TECHNICAL SPECIFICATION LS5 STANDARD TRAVEL

Maximum Force (Tension and Compression)	5000N (1124lbf)
Crosshead Travel Between Eye Ends	800mm (31.5in)
Throat Depth	150mm (5.9in)
Displayed Distance Resolution	0.01mm (.001in)
Crosshead Speed Range	0.01 to 1016mm/min (0.001-40in/min)
Crosshead Speed Accuracy - Unloaded	+/-0.2% of Selected Speed - 2% to 100% of Max Speed
Load Cell Force Accuracy	+/-0.5% of Reading - 1% to 100% of Max Force
Internal Data Sampling Rate	8000Hz (8000 samples per second)
Data Transfer Rate Using NEXYGENPlus™	1000Hz (1000 samples per second)
Operating Temperature	5°C to 35°C (40°F to 95°F)
Relative Humidity	20% to 85% (Non-Condensing)
Supply Voltage	115+/-10%VAC or 230+/-10%VAC
Supply Frequency	50-60Hz
Power Rating	115VAC @ 6.3A or 230VAC @ 6.3A
Fuses (2) for 115VAC & 230VAC Units	T6A3H250V (6.3A Slow Blow Ceramic)
Frame Deflection at Maximum Force	1.7mm (0.067in) Maximum
Weight of Machine	65kg (143lb)

### 12.4 TECHNICAL SPECIFICATION LS2.5 EXTENDED TRAVEL

Maximum Force (Tension and Compression)	2500N (562lbf)
Crosshead Travel Between Eye Ends	1400mm (55.1in)
Throat Depth	150mm (5.9in)
Displayed Distance Resolution	0.01mm (.001in)
Crosshead Speed Range	0.01 to 2032mm/min (0.001-80in/min)
Crosshead Speed Accuracy - Unloaded	+/-0.2% of Selected Speed - 2% to 100% of Max Speed
Load Cell Force Accuracy	+/-0.5% of Reading - 1% to 100% of Max Force
Internal Data Sampling Rate	8000Hz (8000 samples per second)
Data Transfer Rate Using NEXYGENPlus™	1000Hz (1000 samples per second)
Operating Temperature	5°C to 35°C (40°F to 95°F)
Relative Humidity	20% to 85% (Non-Condensing)
Supply Voltage	115+/-10%VAC or 230+/-10%VAC
Supply Frequency	50-60Hz
Power Rating	115VAC @ 6.3A or 230VAC @ 6.3A
Fuses (2) for 115VAC & 230VAC Units	T6A3H250V (6.3A Slow Blow Ceramic)
Frame Deflection at Maximum Force	1.7mm (0.067in) Maximum
Weight of Machine	75kg (165lb)

## 12.5 OVERALL DIMENSIONS LS

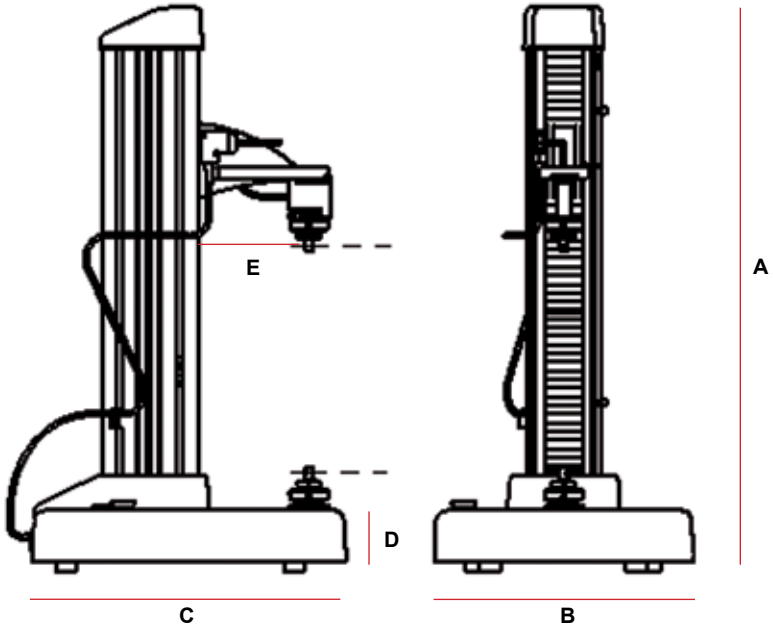

LS1		mm	in
A	Height (standard travel)	1016	40.0
A	Height (extended travel)	1301	51.2
B	Width (excluding console)	460	18.1
C	Depth	557	21.9
D	Base Height	108	4.3
E	Throat Depth	180	7.1

LS5		mm	in
A	Height (standard travel)	1301	51.2
A	Height (extended travel)	1910	75.2
B	Width (excluding console)	460	18.1
C	Depth	557	21.9
D	Base Height	108	4.3
E	Throat Depth	150	5.9

### 13.0 RoHS TABLES

零件或组件名称	有毒的、危险的物质和元素					
	铅(Pb)	汞(Hg)	镉(Cd)	六价铬(Cr6+)	聚溴化联苯(PBB)	聚溴化苯基醚(PBDE)
底盘	○	○	○	○	○	○
柱	○	○	○	○	○	○
移动臂	○	○	○	○	○	○
下支架	○	○	○	○	○	○
保护外套	○	○	○	○	○	○
PCB - 处理器	○	○	○	○	○	○
PCB - 马达控制	○	○	○	○	○	○
PCB - 控制台	○	○	○	○	○	○
通讯线	○	○	○	○	○	○
变压器	○	○	○	○	○	○
马达	○	○	○	○	○	○
变速箱	○	○	○	○	○	○
丝杆	○	○	○	○	○	○
开关组件	○	○	○	○	○	○
载荷传感器	○	○	○	○	○	○
垫子	○	○	○	○	○	○
防护帘	○	○	○	○	○	○
控制台	○	○	○	○	○	○
○ - 表示危险物含量低于要求限制。 X - 表示危险物含量高于要求限制。						

Restricted Substance Status Table Page 1

Part or Assembly Names MT	Toxic and Hazardous Substances and Elements					
	Lead (Pb)	Mercury (Hg)	Cadmium (Cd)	Hexavalent Chromium (Cr6+)	Polybrominated biphenyls (PBB)	Polybrominated diphenyl ethers (PBDE)
Chassis	○	○	○	○	○	○
Column	○	○	○	○	○	○
Moving arm	○	○	○	○	○	○
Lower bracket	○	○	○	○	○	○
Casings	○	○	○	○	○	○
PCB - Processor	○	○	○	○	○	○
PCB - Motor control	○	○	○	○	○	○
PCB - Console	○	○	○	○	○	○
Looms	○	○	○	○	○	○
Transformer	○	○	○	○	○	○
Motor	○	○	○	○	○	○
Gearbox	○	○	○	○	○	○
Leadscrew	○	○	○	○	○	○
Switch assembly	○	○	○	○	○	○
Load cell	○	○	○	○	○	○
Matting	○	○	○	○	○	○
Blinds	○	○	○	○	○	○
Console	○	○	○	○	○	○
○ - indicates hazardous substance level contained is below the required limit. X - indicates hazardous substance level contained is above the required limit.						

Restricted Substance Status Table Page 2



## 14.0 SPARE PARTS KITS

### SPARE PARTS KITS, SINGLE COLUMN L51 SERIES

ITEM	PART NO.	DESCRIPTION	ITEM	PART NO.	DESCRIPTION
1	SPK/LS/0004/A	MOTOR DRIVE PC BOARD ASSEMBLY – L5 SERIES	26	SPK/LS/0029/A	LOWER BEARING ASSEMBLY – L51 SERIES
2	SPK/LS/0005	PROCESSOR PC BOARD ASSEMBLY – L5 SERIES	27	SPK/LS/0030	UPPER BEARING – L5 SERIES
3	SPK/LS/0006/A	MOTOR ASSEMBLY WITH ENCODER – L51 SERIES	28	SPK/LS/0031/A	LEADSCREW ASSEMBLY, L51 STANDARD TRAVEL
4	SPK/LS/0007	CROSS-HEAD LIMIT ACTUATOR ARM – L5 SERIES	28	SPK/LS/0031/B	LEADSCREW ASSEMBLY, L51 EXTENDED TRAVEL
5	SPK/LS/0008	LIMIT STOP SCREW ASSEMBLY – L5 SERIES	29	SPK/LS/0032	LOOM – LIMIT SWITCHES TO PMR DRIVE – L5 SERIES
6	SPK/LS/0009	HAND REMOTE ASSEMBLY – L5 SERIES	30	SPK/LS/0033	LOOM – MOTOR TO MOTOR DRIVE – L51 SERIES
7	SPK/LS/0010	HAND REMOTE LOOM ASSEMBLY – L5 SERIES	31	SPK/LS/0034	LOOM – PSU TO E-STOP SWITCH – L5 SERIES
8	SPK/LS/0011/A	FUSE, L51 SERIES, (1PAIR)	32	SPK/LS/0035/A	FOLDING COVER 500–800mm TRAVEL (1 PAIR) – L5 SERIES
9	SPK/LS/0012	MAIN CONTROL CONSOLE ASSEMBLY – L5 SERIES	33	SPK/LS/0036	LIMIT SWITCHES (1 PAIR) WITH HARDWARE – L5 SERIES
10	SPK/LS/0013/A	TRANSFORMER ASSEMBLY – L51 SERIES	34	SPK/LS/0037/A	1/2" WING BOLT – L51 SERIES
11	SPK/LS/0014/A	POWER ENTRY MODULE ASSEMBLY 2.50VAC – L51 SERIES	35	SPK/LS/0038	LOWER ANCHOR BOSS ASSEMBLY – L5 SERIES
12	SPK/LS/0015	E-STOP SWITCH ASSEMBLY – L51 SERIES	36	SPK/LS/0039/A	LINEAR RAIL ASSEMBLY 500mm TRAVEL – L51 SERIES
13	SPK/LS/0016	SAFE-LINE SWITCH ASSEMBLY – L5 SERIES	37	SPK/LS/0040	LINEAR RAIL ASSEMBLY 800mm TRAVEL – L5 SERIES
14	SPK/LS/0017	LOAD CELL LOOM ASSEMBLY – L5 SERIES	38	SPK/LS/0041	TOP COVER – L5 SERIES
15	SPK/LS/0018	MAIN CONSOLE LOOM ASSEMBLY – L5 SERIES	39	SPK/LS/0042	LOWER ANCHOR PIN ASSEMBLY – L5 SERIES
16	SPK/LS/0019	ENCODER LOOM ASSEMBLY – L5 SERIES	40	SPK/LS/0043	POWER SUPPLY UNIT – L5 SERIES
17	SPK/LS/0020	SAFE-LINE LOOM ASSEMBLY – L5 SERIES	40	SPK/LS/0043	RUBBER FOOT (SET OF 4) – L5 SERIES
18	SPK/LS/0021	INTERNAL LOAD CELL LOOM ASSEMBLY – L5 SERIES	41	SPK/LS/0044	MAIN CONSOLE DISPLAY – L5 SERIES
19	SPK/LS/0022	INTERNAL EXTENSOMETER LOOM ASSEMBLY – L5 SERIES	42	SPK/LS/0045	HAND REMOTE CONSOLE DISPLAY BOARD/DISPLAY – L5 SERIES
20	SPK/LS/0023	LOOM ASSEMBLY, POWER SUPPLY TO PROCESSOR PCB – L5 SERIES	43	SPK/LS/0046/A	POWER CORD ASSEMBLY, 115 VAC, US MAINS – L5 SERIES
21	SPK/LS/0024/A	MOTOR PULLEY – L51 SERIES	43	SPK/LS/0046/B	POWER CORD ASSEMBLY, 230 VAC, EURO MAINS – L5 SERIES
22	SPK/LS/0025/A	LEADSCREW PULLEY – L51 SERIES	43	SPK/LS/0046/C	POWER CORD ASSEMBLY, 230 VAC, UK MAINS – L5 SERIES
23	SPK/LS/0026	LOOM MOTOR DRIVE TO PROCESSOR – L5 SERIES	44	SPK/LS/0047/B	POWER CORD ASSEMBLY, 230 VAC, CHINA/AUST MAINS – L5 SERIES
24	SPK/LS/0027/A	LIMIT ROD ASSEMBLY 500mm TRAVEL – L51 SERIES	44	SPK/LS/0047/A	RUBBER MAT – L51 SERIES
24	SPK/LS/0027/B	LIMIT ROD ASSEMBLY 800mm TRAVEL – L51 SERIES	45	SPK/LS/0048	POGO CONVERSION KIT – L5 SERIES
25	SPK/LS/0028	LOWER LIMIT SWITCH ASSEMBLY – L5 SERIES	46	SPK/LS/0049	1 1/4" ANCHOR PIN KIT – L5 SERIES
			47	SPK/LS/0050	SPACER KIT – MACHINE MOUNTING – L5 SERIES



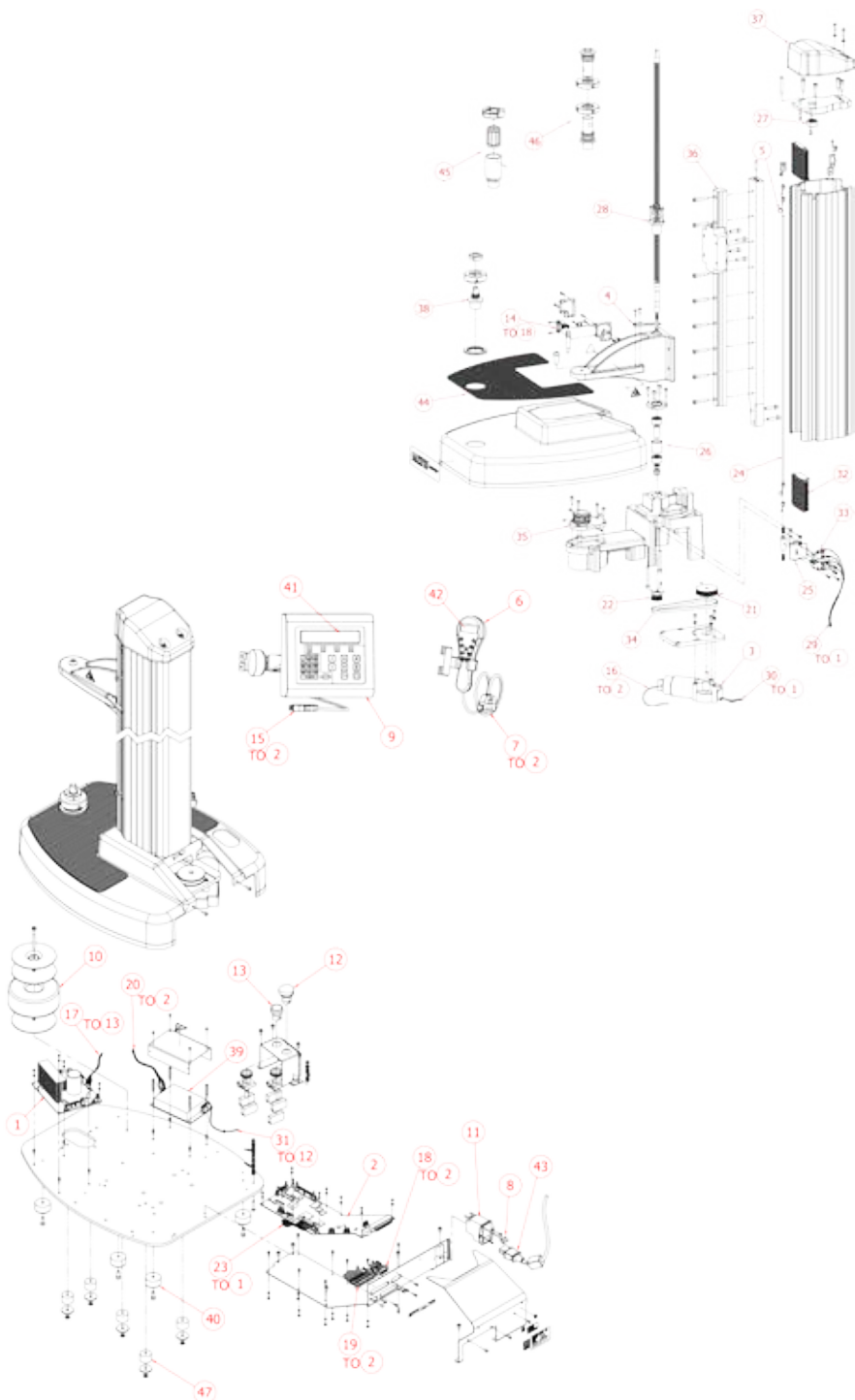

SPARE PARTS KITS, SINGLE COLUMN LS5 & LS2.5 SERIES

ITEM	PART NO.	DESCRIPTION	ITEM	PART NO.	DESCRIPTION
1	SPK/LS/0004/A	MOTOR DRIVE PC BOARD ASSEMBLY – LS SERIES	26	SPK/LS/0029/B	LOWER BEARING ASSEMBLY – LS5 & 2.5 SERIES
2	SPK/LS/0005	PROCESSOR PC BOARD ASSEMBLY – LS SERIES	27	SPK/LS/0030	UPPER BEARING – LS SERIES
3	SPK/LS/0006/B	MOTOR ASSEMBLY WITH ENCODER – LS5 & 2.5 SERIES	28	SPK/LS/0031/C	LEADSCREW ASSEMBLY, LS5 SERIES
4	SPK/LS/0007	CROSSHEAD LIMIT ACTUATOR ARM – LS SERIES	28	SPK/LS/0031/C	LEADSCREW ASSEMBLY, LS2.5 SERIES
5	SPK/LS/0008	LIMIT STOP SCREW ASSEMBLY – LS SERIES	29	SPK/LS/0032	LOOM – LIMIT SWITCHES TO PWM DRIVE – LS SERIES
6	SPK/LS/0009	HAND REMOTE ASSEMBLY – LS SERIES	31	SPK/LS/0034	LOOM – PSU TO E-STOP SWITCH – LS SERIES
7	SPK/LS/0010	HAND REMOTE LOOM ASSEMBLY – LS SERIES	32	SPK/LS/0035/A	FOLDING COVER 500–800mm TRAVEL (3 PAIR) – LS SERIES
8	SPK/LS/0011/B	FUSE, LS5 & 2.5 SERIES (1PAIR)	32	SPK/LS/0035/B	FOLDING COVER 1400mm TRAVEL (1 PAIR) – LS2.5 SERIES
9	SPK/LS/0012	MAIN CONTROL CONSOLE ASSEMBLY – LS5 & 2.5 SERIES	33	SPK/LS/0036	LIMIT SWITCHES (1 PAIR) WITH HARDWARE – LS SERIES
10	SPK/LS/0013/B	TRANSFORMER ASSEMBLY – LS5 & 2.5 SERIES	34	SPK/LS/0037/B	TIMING BELT – LS5 SERIES
11	SPK/LS/0014/C	POWER ENTRY MODULE ASSEMBLY 230VAC – LS5 & 2.5 SERIES	34	SPK/LS/0037/C	TIMING BELT – LS2.5 SERIES
11	SPK/LS/0014/D	POWER ENTRY MODULE ASSEMBLY 115VAC – LS5 & 2.5 SERIES	35	SPK/LS/0038	LOWER ANCHOR BOSS ASSEMBLY – LS SERIES
12	SPK/LS/0015	E-STOP SWITCH ASSEMBLY – LS SERIES	36	SPK/LS/0039/B	LINEAR RAIL ASSEMBLY 800mm TRAVEL – LS SERIES
13	SPK/LS/0016	SAFETY SWITCH ASSEMBLY – LS SERIES	36	SPK/LS/0039/C	LINEAR RAIL ASSEMBLY 1400mm TRAVEL – LS2.5 SERIES
14	SPK/LS/0017	LOAD CELL LOOM ASSEMBLY – LS SERIES	37	SPK/LS/0040	TOP COVER – LS SERIES
15	SPK/LS/0018	MAIN CONSOLE LOOM ASSEMBLY – LS SERIES	38	SPK/LS/0041	LOWER ANCHOR PIN ASSEMBLY – LS SERIES
16	SPK/LS/0019	ENCODER LOOM ASSEMBLY – LS SERIES	39	SPK/LS/0042	POWER SUPPLY UNIT – LS SERIES
17	SPK/LS/0020	SAFE-LINE LOOM ASSEMBLY – LS SERIES	40	SPK/LS/0043	RUBBER FOOT (SET OF 4) – LS SERIES
18	SPK/LS/0021	INTERNAL LOAD CELL LOOM ASSEMBLY – LS SERIES	41	SPK/LS/0044	MAIN CONSOLE DISPLAY – LS SERIES
19	SPK/LS/0022	INTERNAL EXTENSOMETER LOOM ASSEMBLY – LS SERIES	42	SPK/LS/0045	HAND REMOTE CONSOLE DISPLAY BOARD/DISPLAY – LS SERIES
20	SPK/LS/0023	LOOM ASSEMBLY, POWER SUPPLY TO PROCESSOR PCB – LS SERIES	43	SPK/LS/0046/A	POWER CORD ASSEMBLY, 115 VAC, US MAINS – LS SERIES
21	SPK/LS/0024/B	MOTOR PULLEY – LS5 SERIES	43	SPK/LS/0046/B	POWER CORD ASSEMBLY, 230 VAC, EURO MAINS – LS SERIES
21	SPK/LS/0024/C	MOTOR PULLEY – LS2.5 SERIES	43	SPK/LS/0046/C	POWER CORD ASSEMBLY, 230 VAC, UK MAINS – LS SERIES
22	SPK/LS/0025/B	LEADSCREW PULLEY – LS5 & 2.5 SERIES	44	SPK/LS/0047/D	POWER CORD, 230 VAC, CHINA/AUST MAINS – LS SERIES
23	SPK/LS/0026	LOOM MOTOR DRIVE TO PROCESSOR – LS SERIES	45	SPK/LS/0048	RUBBER MAT – LS5 & 2.5 SERIES
24	SPK/LS/0027/B	LIMIT ROD ASSEMBLY 800mm TRAVEL – LS SERIES	45	SPK/LS/0048	POGO CONVERSION KIT – LS SERIES
24	SPK/LS/0027/C	LIMIT ROD ASSEMBLY 1400mm TRAVEL – LS SERIES	46	SPK/LS/0049	1 1/4" ANCHOR PIN KIT – LS SERIES
25	SPK/LS/0028	LIMIT SWITCH ASSEMBLY – LS SERIES	47	SPK/LS/0050	SPACER KIT – MACHINE MOUNTING – LS SERIES

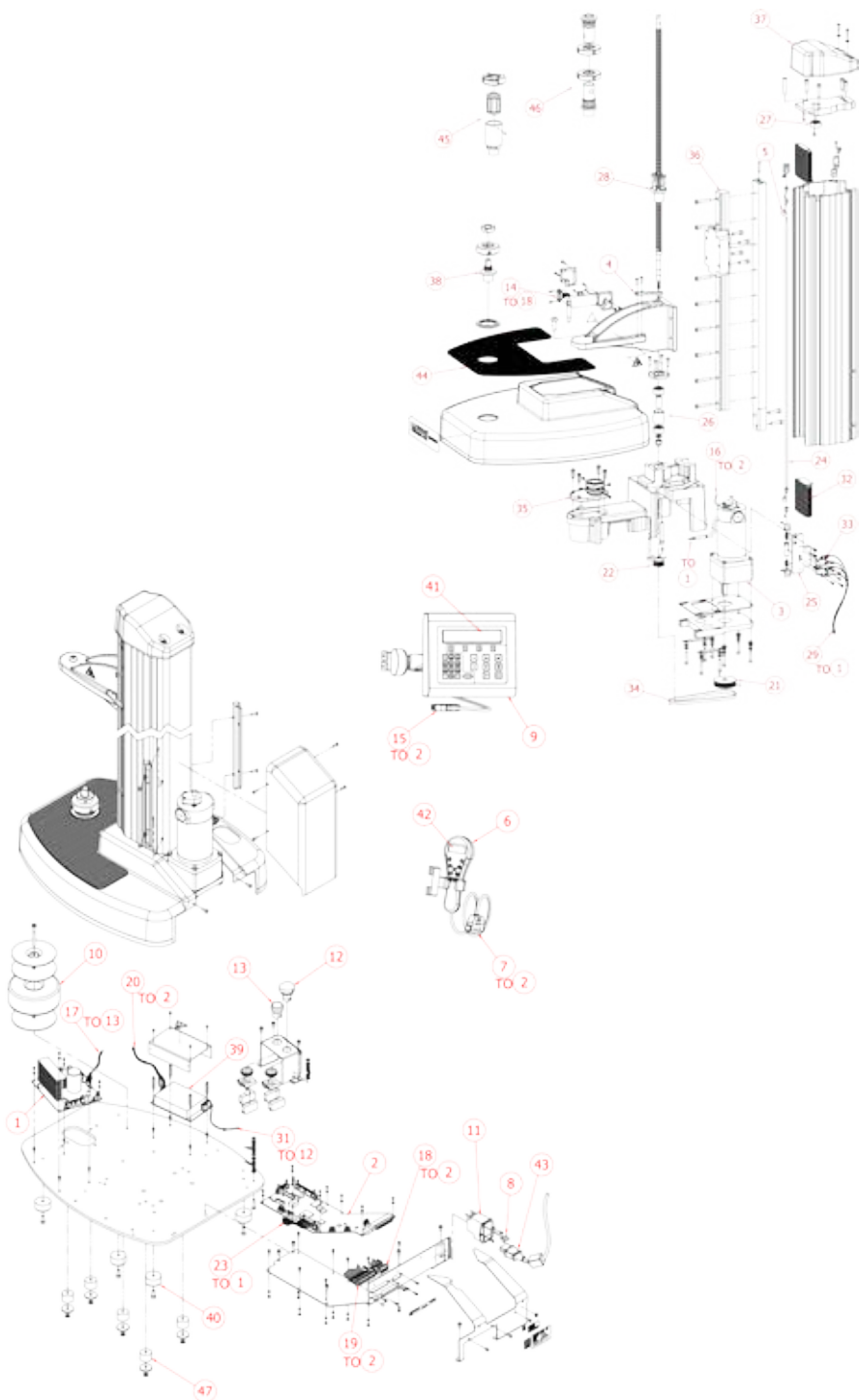

Part No. 01/3682  
March 2013



#### **International Symbols**

##### **WEEE Directive**

This equipment contains electrical and electronic circuits and should not be directly disposed of in a landfill site.



##### **RoHS**

This product is RoHS and China RoHS compliant.

**AMETEK**<sup>®</sup>  
TEST & CALIBRATION INSTRUMENTS

[www.loyd-instruments.com](http://www.loyd-instruments.com)

#### **UK**

Lloyd Instruments Ltd  
Tel +44 (0)1243 833 370  
uk-far.general@ametek.co.uk

#### **France**

AMETEK S.A.S.  
Tel +33 (0)1 30 68 89 40  
general.loyd-instruments@ametek.fr

#### **Germany**

AMETEK GmbH  
Tel +49 (0)2159 9136 510  
info.mct-de@ametek.de

#### **Denmark**

AMETEK Denmark  
Tel +45 4816 8000  
ametekdk@ametek.com

#### **USA**

AMETEK Measurement & Calibration Technologies  
Tel +1 (727) 538 6000  
chatillon.fl-lar@ametek.com

#### **India**

AMETEK Instruments India Pvt Ltd.  
Tel +91 22 2836 4750  
ametekdk@ametek.com

#### **Singapore**

AMETEK Singapore Pte Ltd  
Tel +65 6484 2388  
ametekdk@ametek.com

#### **China**

AMETEK Commercial Enterprise - Shanghai  
Tel +86 21 5868 5111

AMETEK Commercial Enterprise - Beijing  
Tel +86 10 8526 2111

AMETEK Commercial Enterprise - Guangzhou  
Tel +86 20 8363 4768  
loyd@ametek.com.cn